

OPERATION MANUAL

 **GLOBAL SERIES**  
Air-Operated Double Diaphragm Pumps

G50

## Simplified Declaration of Conformity

YAMADA CORPORATION declares under our sole responsibility that the products described below are in conformity with the following standards and/or directives.



EU Declaration of Conformity:

Product : AIR OPERATED DIAPHRAGM PUMP series and PULSATION DAMPENER series

Model : NDP, DP, G, and AD series; excluding NPT thread type

Directive 2006/42/EC, Directive 2014/30/EU (NDP-E and DP-E series), EN ISO 12100:2010,  
EN 809:1998 + A1:2009



UK Declaration of Conformity:

Product : AIR OPERATED DIAPHRAGM PUMP series and PULSATION DAMPENER series

Model : NDP, DP, G, and AD series; excluding NPT thread type

Supply of Machinery (Safety) Regulations 2008, EN-ISO 12100:2010, EN 809:1998 + A1:2009

Manufacturer

Name of company : YAMADA CORPORATION

Address : 1-1-3, Minami-Magome, Ota ku, Tokyo, 143-8504 Japan

Importer / Authorized Representative

Name of company : YAMADA EUROPE B.V.

Address : Aquamarijnstraat 50, 7554NS Hengelo(Ov), the Netherlands

Original declaration is available at the following Internet address:

<https://www.yamada-europe.com/downloads>

## **·Introduction**

Thank you for purchasing a Yamada Diaphragm Pump. This product is a positive-displacement pump that transfers fluids by movement of diaphragms driven by compressed air through a unique switching mechanism.

The diaphragms are made of rubber-based or plastic-based materials.

## **·For safe operation**

This document contains information vital for safe and efficient operation of this product. Before using the pump, be sure to read this document carefully, particularly the "warnings and cautions," and be fully familiar with the operating procedures. Be sure to keep this document handy for future reference.

## Warnings and cautions

For safe use of this product, be sure to note the following: In this document, warnings and cautions are indicated by symbols. These symbols are for those who will operate this product and for those who will be nearby, for safe operation and for prevention of personal injury and property damage.

The following warning and caution symbols have the meanings described below. Be sure to remember their meanings.

 **WARNING:** If you ignore the warning described and operate the product in an improper manner, there is danger of serious bodily injury or death.

 **CAUTION:** If you ignore the caution described and operate the product in an improper manner, there is danger of personal injury or property damage.

Furthermore, to indicate the type of danger and damage, the following symbols are also used along with those mentioned above:



This symbol indicates a DON'T, and will be accompanied by an explanation on something you must not do.



This symbol indicates a DO, and will be accompanied by instructions on something you must do in a certain situation.

## Operating caution

Before using this product

### WARNING



• When using compressed gas (hereinafter called "compressed air") to drive this pump, be sure it is one of the following:

- \* Compressed air supplied from an air compressor
- \* Nitrogen (N<sub>2</sub>) gas

Use of compressed air other than the above may cause air pollution, damage to the pump, or even an explosion.



• Allowable pressure of this product is set based on the strength of the casing as follows.

- \* Casing material - Aluminum 0.7 MPa.

Air pressure and discharge pressure must not exceed the allowable working pressure. If air pressure and discharge pressure exceed the allowable working pressure, it may cause liquid leaks, damaged pump casings or diaphragms and could cause a fatal accident.



• When moving this product, make sure that the internal pressure is released.

If the pump is moved while under pressure, any shock imparted by droppage, etc. may damage the pump or even cause an explosion.



• Hazardous fluids (with strong acid or alkali, flammable or toxic) or gas bubbles generated by such fluids may cause serious injury or even death if accidentally inhaled or consumed or if they come into contact with the eyes or adhere to skin. Therefore, the following precautions are strongly advised.

- \* Be fully familiar with the properties of the fluid to be pumped and work in strict accordance with the operating instructions provided by the suppliers of such fluids (such as wearing goggles, gloves, mask or work clothes).
- \* When storing a hazardous fluid, strictly comply with the regulatory procedures (such as using proper containers, storage conditions, etc.).
- \* Always install the piping and exhaust port of this pump away from human and animal traffic.



• When a diaphragm is damaged, fluid will gush out together with air through the exhaust port. Also when pump has positive suction head, liquid will be forced out from exhaust port due to positive inlet pressure. Make sure to Provide protective measures in consideration of possible leakage of fluid (see NOTE: Arranging outside exhaust on P.9). For example using a hose and pit etc., be sure you are using a model with appropriate corrosion resistance for the fluid to be pumped.

## WARNING



- When installing this product, be sure to connect a ground wire from the specified position of this product.

When this product is installed and operated without the ground wire properly connected, friction between parts, as well as abrasion caused by the flow of some fluids inside the casing, may generate static electricity. Also, depending on the type of fluid being pumped and the installation environment (such as gases in the air and type of surrounding fixtures), static electricity could become a cause of fire or electric shock.



- Improper grounding, poor ventilation, or unshielded fire or spark can create a danger of fire or explosion. Therefore, the following precautions are strongly advised.

- \*All peripheral equipment and piping connected to this product should be properly grounded.
- \*Whenever you notice any spark while operating this product, immediately stop its operation, and do NOT start using it again unless you are sure of the cause and corrective actions have been taken.
- \*Depending upon the type of fluid being pumped, bubbles of flammable gas may be generated. Make sure that ventilation is satisfactory.
- \*This product itself, its piping and exhaust ports should be kept away from unshielded fire, spark and other causes of ignition. If a diaphragm is damaged, fluid will gush out together with air from the exhaust port.
- \*Do NOT leave gasoline or solvent etc. that contains waste at the work site.
- \*Machinery and other equipment near the place of installation of this product should be properly insulated to prevent conduction with each other.
- \*Do NOT operate heating devices that create flames or have heating filaments anywhere near the pump or its piping.
- \*If there are flammable gases in the air while the pump is operating, do NOT switch electric appliance on and off.
- \*Do NOT operate a gasoline engine at the work site.
- \*Restrict smoking at the work site.



- After you shut down the pump and disconnect the piping, some fluid may remain inside the pump. Also, if the pump is left unused for a prolonged period, some fluid may remain inside the pump and connected piping. Therefore, be sure to purge the system of fluid and clean the pump after prolonged disuse.

If the product is left unused for a prolonged period with fluid remaining in the connected piping as well as the pump itself, the fluid may expand, depending on the ambient temperature (because of freezing or heat), which may cause damage to the pump and/or piping, and possible leakage of fluid.



- Always use genuine Yamada parts when replacing component parts of this product. Do NOT attempt to modify the components parts or replace them with other than genuine Yamada parts.



- Torque of all tightening parts must be inspected before operation. Designated torque are mentioned in maintenance manual.

## ⚠️ WARNING



• When pumping a hazardous fluid (hot, flammable, strong acid, etc.) with this product, provide protective measures (install a pit, a protection box, sensors, etc.) in consideration of possible leakage of fluid, and post warning signs at necessary places.

Make the warning symbols in “12.Warning symbols”, and attach them to the casing and piping, etc. Leakage of fluid may cause fire, air pollution or a serious accident. When pumping a hot fluid, the casing and piping will become hot, which may burn the skin when touched.

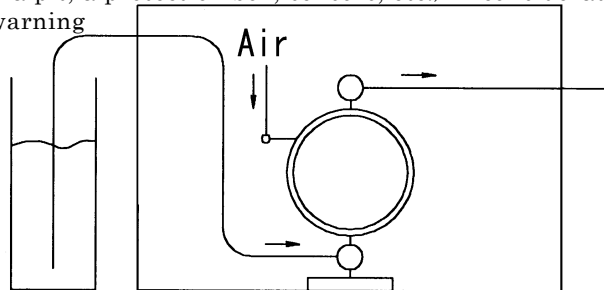

Fig.0.1



• Before using this product, be sure you are familiar with the precautions regarding the fluid to be pumped, and verify the corrosion resistance of the parts that will come into contact with the fluid. NEVER use the product with any fluid against which it does not have sufficient corrosion resistance or with a fluid that poses a risk of explosion. If you are unsure of the corrosion resistance, contact your dealer or our regional office. If you use this product with any fluid against which the parts that will come in contact with the fluid do not have sufficient corrosion resistance, it may result in damaging the product or leakage of fluid.



• When working in the vicinity of pumping of fluid with this product, be sure to wear protective gear (goggles, mask, etc.).



• When using this product, observe the relevant regulatory rules concerning fire prevention, labor safety standards, etc.



• If you have any questions on the operation of this product (method of connection or installation), contact your dealer or our regional office.

## ⚠️ CAUTION



• When operating this product, it may generate loud operating noise, depending upon the condition of use (fluid pumped, supply air pressure and discharge pressure). If regulatory rules apply, provide appropriate acoustic measures where necessary. (For the noise value of this product, see “10.1 Main specifications”.)



• To drive this product, use supply air with minimum moisture content.



• If a diaphragm of this product is damaged, supply air may mix with the fluid or the fluid may flow into the main body (air-switching portion). If air supply is inadequate or contaminated, do NOT operate the pump.



• While operating this product, do NOT cover the intake port by hand.



• If the pump remains unused for a long period of time, or you have misgivings about running the pump, please consult with the dealer where you purchased it or our Sales office.

# Table of contents

<b>Introduction</b> .....	1
<b>For safe operation</b> .....	1
<b>Warnings and cautions</b> .....	2
<b>Operating caution</b> .....	2
<b>Table of contents</b> .....	5
<b>1. Names of parts and materials</b> .....	6
<b>2. Assembly</b>	
2.1 Installation of accessories .....	7
<b>3. Installation</b>	
3.1 Method of transport .....	8
3.2 Installing the pump .....	8
3.3 Connecting the ground wire .....	10
<b>4. Connection</b>	
4.1 Connecting fluid piping .....	11
4.2 Connecting air piping .....	12
<b>5. Operation</b>	
5.1 Method of operation .....	13
5.2 Flow adjustment .....	13
5.3 Shutdown .....	14
5.4 Releasing the pressure .....	14
<b>6. Method of cleaning</b> .....	15
<b>7. Daily check</b> .....	16
<b>8. Troubleshooting</b>	
8.1 Pump does not run .....	16
8.2 Pump runs, but fluid does not come out .....	16
8.3 Flow (discharge quantity) decreased .....	16
8.4 Fluid leaks from exhaust port (silencer) .....	17
8.5 High air consumption during in operation .....	17
8.6 Irregular noise .....	17
8.7 Irregular vibration .....	17
<b>9. Returning the product for servicing</b>	
9.1 Before returning the product .....	17
<b>10. Main body specifications</b>	
10.1 Main specifications .....	18
10.2 Appearance and dimensions .....	19
10.3 Performance curve .....	20
<b>11. Limited warranty</b> .....	21
<b>12. Warning symbols</b> .....	22

# 1. Names of parts and materials

- A : Manifold
- B : Out Chamber
- C : Pump Base
- D : Discharge Port
- E : Intake Port
- F : Lift Point
- G : Ground Connection Point
- H : Reset Button
- J : Air Valve

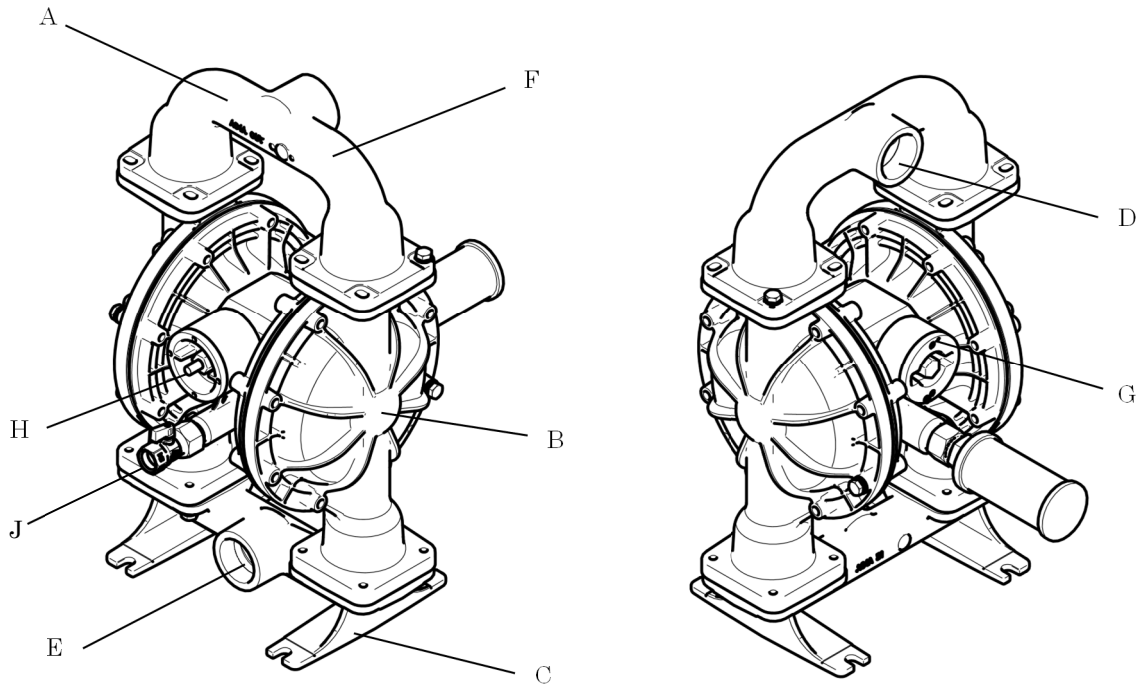

Type	AN	AT	AH	AS
Switching Portion	ADC12			
Fluid contact Portion	ADC12, AC4A-T6			
Diaphragm	NBR	PTFE, TPO	TPEE	TPO
Ball	NBR	PTFE	TPEE	TPO
O Ring	—	PTFE	NBR	EPDM
Valve Seat	NBR	A5056		
Center Disk	ADC12			

## ■ List of accessories

- Simple Operation Manual .....1
- Air Valve .....1
- Silencer .....1

## 2. Assembly

### 2.1 Installation of accessories

- 1) First, open the product package and make sure that all the accessories are in order (see “1. Names of parts and materials” ■ List of accessories).
- 2) Attach the air valve and the silencer (see the appearance drawings on “1. Names of parts and materials”).

### CAUTION



·All of the connection parts are capped or taped for shipment. Remove the caps and tapes.



·When installing accessories, make sure that no foreign matter falls into the product, as it could cause malfunction of the switching portion.



·Use PTFE tape when installing air valve.



·See “10.1 Main specifications”. Remember that the pump is heavy, so extreme care must be taken when lifting it.



## ⚠ CAUTION



· Even if you do not use the cushions to secure the pump in place, mount it in such a way that vibration generated by pump operation will be absorbed.



· If the pump will be submerged during operation, follow the steps below:

\* Verify the corrosion resistance of each component of the pump, and do NOT expose the pump to any fluid for which it does not have proper corrosion resistance.

\* Exhaust should be directed outside, not into the fluid in which the pump is submerged.

For information on how to arrange the exhaust, see Note: Arranging outside exhaust and Fig. 3.2 below.

\* Make sure that you can reach all of the valves without submerging your hand.



· When operating the pump, operation noise may be generated, depending upon conditions of use (kind of fluid being pumped, supply air pressure and discharge pressure).

If any regulatory rules apply, provide appropriate acoustic measures. (For the noise level of this product, see “10.1 Main specifications”.)



· When pumping a hazardous fluid (hot, flammable, strong acid, etc.), provide protective measures (installation of a pit or sensors, etc.) in consideration of possible leakage of fluid, and post warning signs at necessary places. For details, see the applicable operating caution on P.2 and P.4.

## ⚠ WARNING



· If using the pump with a flammable fluid or in a flammable environment, read the applicable operating caution on P.3.

### <NOTE> Arranging outside exhaust

· Remove the silencer.

· Connect a hose with a ground wire to the pump's exhaust port, and attach the silencer to the tip of the hose. Use a hose of the same diameter as the exhaust port. (If the hose is longer than 5 meters, consult your dealer or our regional office.)

· Have a pit, a protection box, etc. at the end of the hose.

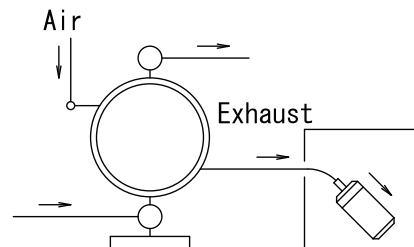

Fig. 3.2

## ⚠ WARNING



· Be sure to have a pit, a protection box, etc. at the end of the hose in preparation for the flow of fluid in case of damage to a diaphragm. For details, see the applicable operating caution on P.2.



· Pump exhaust should be directed to a safe place, away from people, animals and food.

### <NOTE> Solenoid Operation

When air line operation is to be controlled by a solenoid valve, a three way type is recommended.

A three way solenoid valve allows any trapped air to bleed off, in turn improving pump performance.

### 3.3 Connecting the ground wire

- a) When installing the pump, be sure to connect the ground wire at the specified position. For the specified position for connecting the ground wire, see “1. Names of parts and materials”.
- b) Also connect ground wires to peripheral equipment and piping.
- c) Use 2.0 mm<sup>2</sup> minimum ground wire.

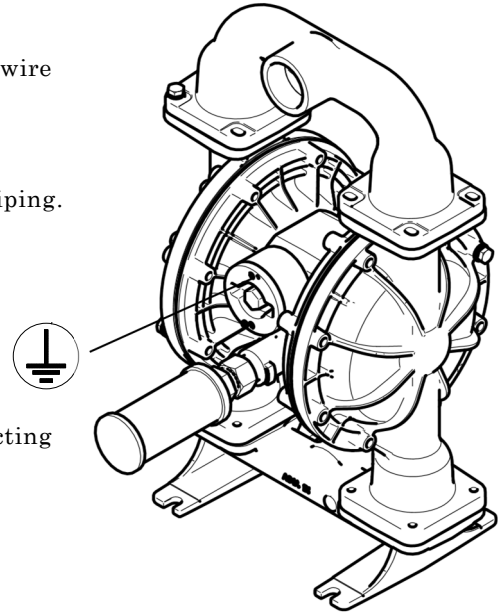

Position for connecting  
the ground wire

Fig.3.3

## WARNING



·Be sure to connect ground wires to the connected piping and any other connected equipment. For details, see the applicable operating caution on P.3.  
When the pump is operated without a ground wire or otherwise not properly grounded, friction between parts and abrasion caused by some fluids flowing inside the casing may generate static electricity. Also, depending on the type of fluid being pumped and the installation environment (such as gases in the air or the surrounding fixtures), it may be a cause of fire or electric shock.

## 4. Connection

### 4.1 Connecting fluid piping

- 1) Connect a flow valve and a drain valve to the fluid discharge port of the pump.
- 2) Connect a valve for maintenance to the fluid suction intake port of the pump.
- 3) Connect a hose to the valve on the suction-port side and the valve of the discharge-port side of the pump.
- 4) Connect a hose on the suction-side intake and the discharge-port side to the respective vessels.

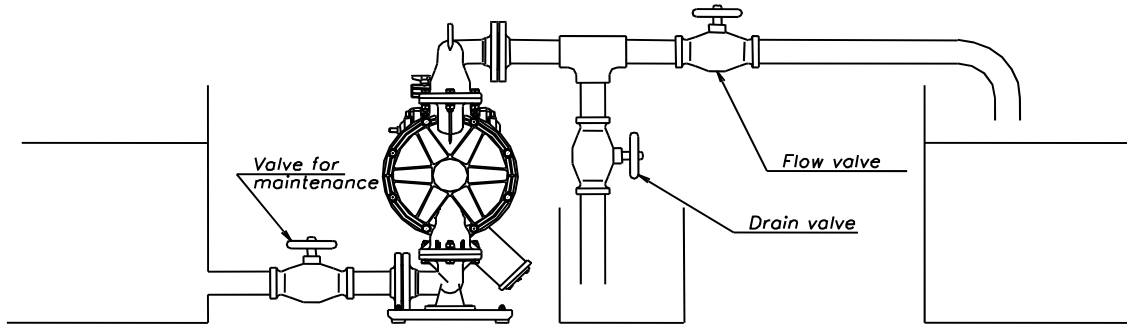

Fig.4.1

## ⚠ CAUTION



·Use a flexible hose to absorb pump vibration, and ground the hose.



·Make sure that there will be no external force on any connection part of the pump. Be especially careful not to have the pump support part of the weight of the hose and the piping.



·Use a sturdy hose that will not collapse under the strong suction of the pump. Also, make sure the hose is of more than sufficient pressure rating.



·Use a hose of a diameter the same as or larger than the pump's ports. If you use a hose of smaller diameter, the pump's performance will be adversely affected, and it may even malfunction.



·When pumping a fluid that contains slurry, verify that the particle size is below the slurry limitation (see "10.1 Main specifications"). If it exceeds the limitation of slurries indicated in the main specifications, attach a strainer to the pump to stop larger particles. Otherwise, such particles may cause a malfunction.



·If, depending upon the place of pump installation, the volume of the pumped fluid changes drastically, install a relief valve on the discharge side, and bring the pressure down below the maximum permissible value. If, owing to a change in the volume of fluid, the pressure inside the pump exceeds the maximum permissible pressure, it may cause damage.



·Keep a vessel below the relief valve to catch any drain off.

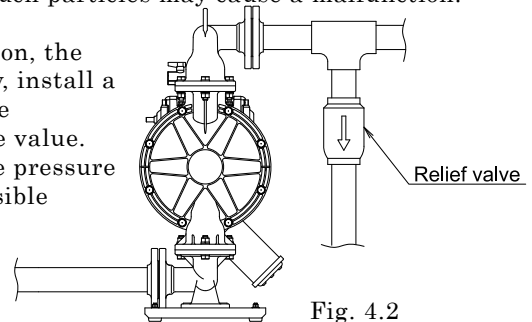

Fig. 4.2



·When testing piping for leakage, do NOT apply pressure to the pump's inlet and outlet sides with compressed air from outside. It may cause abnormal breakage to the diaphragm or the switching portion. When testing the piping, either install a valve between the pump's suction inlet and the discharge outlet and piping, or disconnect the pump from the piping and install plugs so that there will be no pressure from outside.



·In our product inspection, clean water is used. To prevent mixture of dirty water into the fluid to be pumped, clean the inside of the pump before finishing installation work.



·When installing a standby pump or two pumps in parallel form, be sure to provide a valve on each of the intake port and the discharge port sides and perform pump switching by using the liquid material valve. If the valve of the stop-side pump is open, the diaphragm will be inverted by the discharge pressure of the operating-side pump, resulting in damage in an early stage.

## 4.2 Connecting air piping

### ⚠ WARNING



· Before starting work, make sure that the air compressor is shut off.

- 1) Connect an air valve, air filter, regulator and if necessary lubricator (hereinafter called the "peripheral equipment") to hose which connected to compressor. Refer (NOTE) for detail information.
- 2) Install these peripheral items supported by brackets, etc., near the pump.
- 3) Connect the hose from the peripheral equipment to the air valve of the pump's supply port.

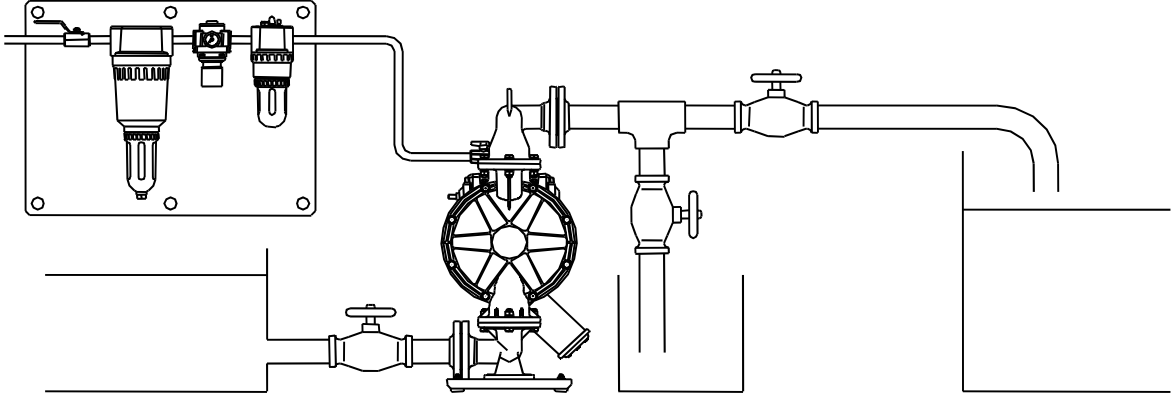

Fig.4.3

### ⚠ CAUTION



· Use a flexible hose to absorb pump vibration, and ground the hose.



· Make sure that there will be no external force on any connection part of the pump. Be especially careful not to have the pump support part of the weight of the hose and the piping.



· The piping and the peripheral equipment may become clogged with sludge. Clean the inside of the piping for 10 to 20 seconds before connecting it to the pump.







· Be sure to sufficiently ground the piping and peripheral equipment.

#### <NOTE>



- Air piping size should be equal to the inlet port of the pump to supply enough air to run the pump. The air compressor should be able to provide adequate air flow to the pump. Attach the compressor as close as possible to the pump, considering operability and stability of air pressure.
- If you use a solenoid valve as the air valve, be sure it is a three-way valve. When the valve is closed, the internal compressed air of the pump will be released, and this will switch the spool to its normal position.
- Use of a coupler for the connection part of each hose will make operation and maintenance easier.
- If you use the pump intermittently the pump will not require lubrication. However lubrication is recommended if running the pump continuously for long periods or using very dry air or at high temperatures. This will guarantee the life of the pumps seals.
  - High temperature operation: When transferring liquid whose temperature exceeds 70 °C
  - Continuous operation: When the pump operates continuously for longer than 1 hour and is stopped for less than 15 minutes.
  - Lubrication: Use only turbine oil Class 1 grade oil (equivalent to ISO VG 32), under the following conditions; Oil concentration at 50 mg/m<sup>3</sup>, Absolute pressure at 0.1 MPa. Maximum temperature of 20 °C and Humidity at 65%.

## 5. Operation

### 5.1 Method of operation





 CAUTION	
	· Before starting the pump, make sure that all piping is properly connected.
	· Also, before starting the pump, make sure that all the bolts are securely tightened. (Refer to the maintenance manual for the bolts that a regulation torque are explained.)
	· Make sure that the air valve, regulator and the drain valve on the discharge side are closed. Also, make sure that the valve on the suction side is opened.

- 1) Start the air compressor.
- 2) Open the air valve in front of each piece of peripheral equipment, and adjust the supply air pressure with a regulator to within the permissible range (see “10.1 Main specifications”).
- 3) Open the flow valve on the discharge side.
- 4) Press the reset button, and then slowly open the air valve of the pump.
- 5) First, verify that fluid is flowing inside the piping and is being pumped to the discharge side, and then fully open the air valve.
- 6) Again adjust the supply air pressure with a regulator to within the permissible range (see “10.1 Main specifications”).

 CAUTION	
	· Do NOT open the air valve suddenly.
	· In case of use lubricator, must be used turbine oil none addition class 1 turbine oil (equivalent ISO VG32 grade) for lubricants. Do not apply lubricants more than required and also do not use any other lubricants, which designated on this instruction manual. This may cause of pump problem and there is danger of serious bodily damage.

### 5.2 Flow adjustment

- Adjust the flow valve on the discharge side. For the relationship among the flow, supply air pressure and discharge pressure, see “10.3 Performance curve”.

 CAUTION	
	· As you start closing the flow valve, the supply air pressure may rise. Make sure that the pressure is kept within the normal operating range (see “10.1 Main Specifications”).
	· Depending upon the viscosity and specific gravity of the fluid, the suction stroke and other conditions, the permissible suction flow speed of fluid into the pump will vary; however, if the pump speed (flow speed of fluid) increases greatly, cavitation will occur, and this not only will reduce pump performance, but it may cause a malfunction. Adjust the supply air pressure as well as the flow in order to prevent cavitation.
	· If fluid is not discharged after you start the pump, or if you hear an abnormal noise or notice any irregularity, shut down the pump immediately (see “8. Troubleshooting”).

### 5.3 Shutdown

- Close the air valve of the pump and shut off the supply air.

#### CAUTION



·There is no problem in shutting down the pump with the flow valve closed while air is being supplied; however, if this condition continues for many hours while there is nobody watching the pump, it may continue running when there is a leak from the pump or piping, and fluid may continue flowing out of the position of leakage. Upon finishing your work, release the internal pressure from the pump and close the air valve (see “5.4 Releasing the pressure”).



·When the pump is shut down while pumping slurry, particulate matter contained in the slurry will be deposited and get stuck inside the out chamber. If the pump is started again as is, the diaphragm may be damaged or the center disk may be overloaded, and this may cause damage such as bending of the center rod. After finishing your work, purge the remaining fluid from the pump (see “6. Method of cleaning”).

### 5.4 Releasing the pressure

- 1) Make sure that the air valve of the pump is closed.
- 2) Shut down the air compressor or close the valve on the air-supply side of the peripheral equipment.
- 3) Close the flow valve on the discharge side, start slowly opening the drain valve, and discharge the fluid under pressure.
- 4) Open the air valve of the pump, start running the pump, and discharge the remaining air.
- 5) After making sure that the pump has been shut down and the pressure has been released, fully open the regulator, and close the air valve and drain valve of the pump.

#### CAUTION



·Keep a vessel below the relief valve to catch any drain off.



·Fluid under pressure will gush out as soon as you open the valve, so be careful.



·If the pump will be unused for a prolonged period, purge and clean the pump (see the Operating caution on P.3).

## 6. Method of cleaning

### WARNING



·Before starting operation, make sure that compressed air is not supplied to the pump.



·Before starting operation, make sure that the pump is not pressurized.

- 1) Remove the hose from the suction side of the pump.
- 2) Close the flow valve on the discharge side, open the drain valve, and then operate a pump by starting air pressure for a while to discharge any fluid remaining inside the pump as much as possible.
- 3) Remove the hose from the discharge side, and attach different hoses to the suction side and the discharge side for cleaning.
- 4) Be ready with a vessel with cleaning solution, select cleaning solution appropriate for the type of fluid pumped, and then connect the suction-side and the discharge-side hoses of the pump.
- 5) Operate a pump by starting air pressure slowly, and let the cleaning solution circulate for sufficient cleaning.
- 6) Finally, flush with clean water.
- 7) Remove the hose from the suction side of the pump, run the pump for a while and purge the pump of remaining fluid as much as possible.

### CAUTION



·Be careful when removing piping. Fluid will gush out.



·After cleaning with clean water, turn the pump upside-down to drain out the water.

## 7. Daily check

- Before starting pump operation, be sure to conduct the following check every day. If any irregularity is found, do NOT start running the pump until the cause of the irregularity has been found and corrective measures have been taken.
  - a) Verify the drain flow through the air filter.
  - b) If using a lubricator, verify the quantity of lubricating oil.
  - c) Make sure that there is no leakage of fluid from any connection part or the pump.
  - d) Make sure that there are no cracks in the pump casing or piping.
  - e) Check the tightness of every bolt of the pump and retighten if necessary. For details, see the maintenance manual.
  - f) Make sure that the connection parts of the piping and peripheral equipment are not loose.
  - g) Make sure that each consumable parts of the pump has not been inspected or replaced. For details, see the maintenance manual.

## 8. Troubleshooting

### 8.1 Pump does not run

Cause	Action to be taken
The exhaust port (silencer) of pump is clogged with sludge.	Check and clean the exhaust port and silencer.
Air is not supplied.	Start the compressor, and open the air valve and air regulator.
The supply air pressure is low.	Check the compressor and the configuration of air piping.
Air leaks from connection parts.	Check the connection parts and tightness of bolts.
Air piping or peripheral equipment is clogged with sludge.	Check and clean the air piping.
The flow valve on the discharge side is not open.	Open the flow valve on the discharge side.
The spool stopped in neutral position.	Press the RESET button.
The fluid piping is clogged with sludge.	Check and clean the fluid piping.
The pump is clogged with sludge.	Disassemble the casing, check and clean.

### 8.2 Pump runs, but fluid does not come out

Cause	Action to be taken
The suction lift or discharge head is long.	Confirm the piping configuration and shorten the length.
The discharge-side fluid piping (including the strainer) is clogged with sludge.	Check and clean the fluid piping.
The valve on the suction side is not open.	Open the valve on the suction side.
The pump is clogged with sludge.	Disassemble the casing, check and clean.
The ball and valve seat are worn out or damaged.	Disassemble the manifold, check and replace parts.

### 8.3 Flow (discharge volume) decreased

Cause	Action to be taken
The supply air pressure is low.	Check the compressor and configuration of air piping.
Air piping or peripheral equipment is clogged with sludge.	Check and clean the air piping.
The discharge-side flow valve opens differently.	Adjust the discharge-side flow valve.
Air is taken in together with fluid.	Replenish fluid and check the configuration of the suction-side piping.
Cavitation occurs.	Adjust the supply air pressure and discharge pressure, and shorten the suction lift.
Chattering occurs.	Adjust the supply air pressure and discharge pressure. Reduce inlet flow valve to adjusting liquid pressure and volume.
Icing on air-switching portion.	Eliminate ice from air-switching valve and check and clean the air filter. Use external exhaust hose to control exhaust air speed. (Refer Fig.3.2)
The fluid piping (including the strainer) is clogged with sludge.	Check and clean the fluid piping and strainer.

The exhaust port (silencer) of the pump is clogged with sludge.	Check and clean the exhaust port and silencer.
The pump is clogged with sludge.	Disassemble the casing, check and clean.

#### 8.4 Liquid leakage from exhaust port (silencer)

Cause	Action to be taken
The diaphragm is damaged.	Disassemble and check the pump and replace the diaphragm.
Fluid side center disk is loose.	Disassemble and check the pump. Tighten the center disk.

#### 8.5 High air consumption during operation

Cause	Action to be taken
The seal ring and sleeve are worn out.	Disassemble the air-switch portion, check and clean. Replace parts as necessary.

#### 8.6 Irregular noise

Cause	Action to be taken
The supply air pressure too high.	Adjust the supply air pressure.
The spool oscillates, and occur ball chattering.	Adjust the supply air pressure and discharge pressure. Reduce inlet flow valve to adjusting liquid pressure and volume.
The pump is clogged with sludge with particles of larger than the permissible diameter.	Disassemble the casing, check and clean.

#### 8.7 Irregular vibration



Cause	Action to be taken
The supply air pressure is too high.	Adjust the supply air pressure.
The spool oscillates, and occur ball chattering.	Adjust the supply air pressure and discharge pressure.
Connection parts and pump mounting are loose.	Check each connection part and tighten the bolts.



- If disassembly is required, refer to the maintenance manual and follow with the instructions.
- If any of the above mentioned causes does not apply to your problem, contact your dealer or our regional office.

### 9. Returning the product for servicing

#### 9.1 Before returning the product

- 1) Purge the pump of fluid and clean (see "6. Method of cleaning").
- 2) Return the product in the same package as when it was first shipped from the factory.

 <b>WARNING</b>	
	·It will be the end-user's responsibility thoroughly wash and clean the pumps to prevent accidents caused by liquid leaks.

 <b>CAUTION</b>	
	·Be sure to prevent liquid leak from pump for safe transport.

## 10. Main body specifications

### 10.1 Main specifications

Type		A_	AT
Nominal Diameter		2" (50 mm)	
Fluid Connection	Suction Port	Rc 2	
	Discharge Port		
Air Connection	Supply Port	Rc 3/4	
	Exhaust Port	Rc 1	
Operating Air Pressure		0.2 - 0.7 MPa	
Maximum Discharge Pressure		0.7 MPa	
Discharge Volume/cycle*1		2400 mL	
Maximum Discharge Volume		670 L/min	640 L/min
Maximum Air Consumption		5400 L/min(ANR)	
Slurry Limitation		8mm or less	
Limitation of Viscosity		Suction Lift : 3Pa·s or less Force In : 8Pa·s or less	
Operating Temperature Range	Temp. Ambient	0 - 70 °C	
	Temp. Liquid	*2	
A-weighted emission sound pressure level*3		88.5 dB	96.5 dB
A-weighted sound power level*4		102 dB	108 dB
Weight		29 kg	30 kg

\*1.Discharge Volume/cycle is highly dependent on application. Contact your local distributor or Yamada for more information.

\*2.Diaphragm                   NBR : 0 - 70 °C  
                                      TPEE : 0 - 80 °C  
                                      TPO/PTFE : 0 - 100 °C

\*3.The measuring method is based on ISO 1996.

\*4.The measuring method is based on ISO 3744.

## 10.2 Appearance and dimensions

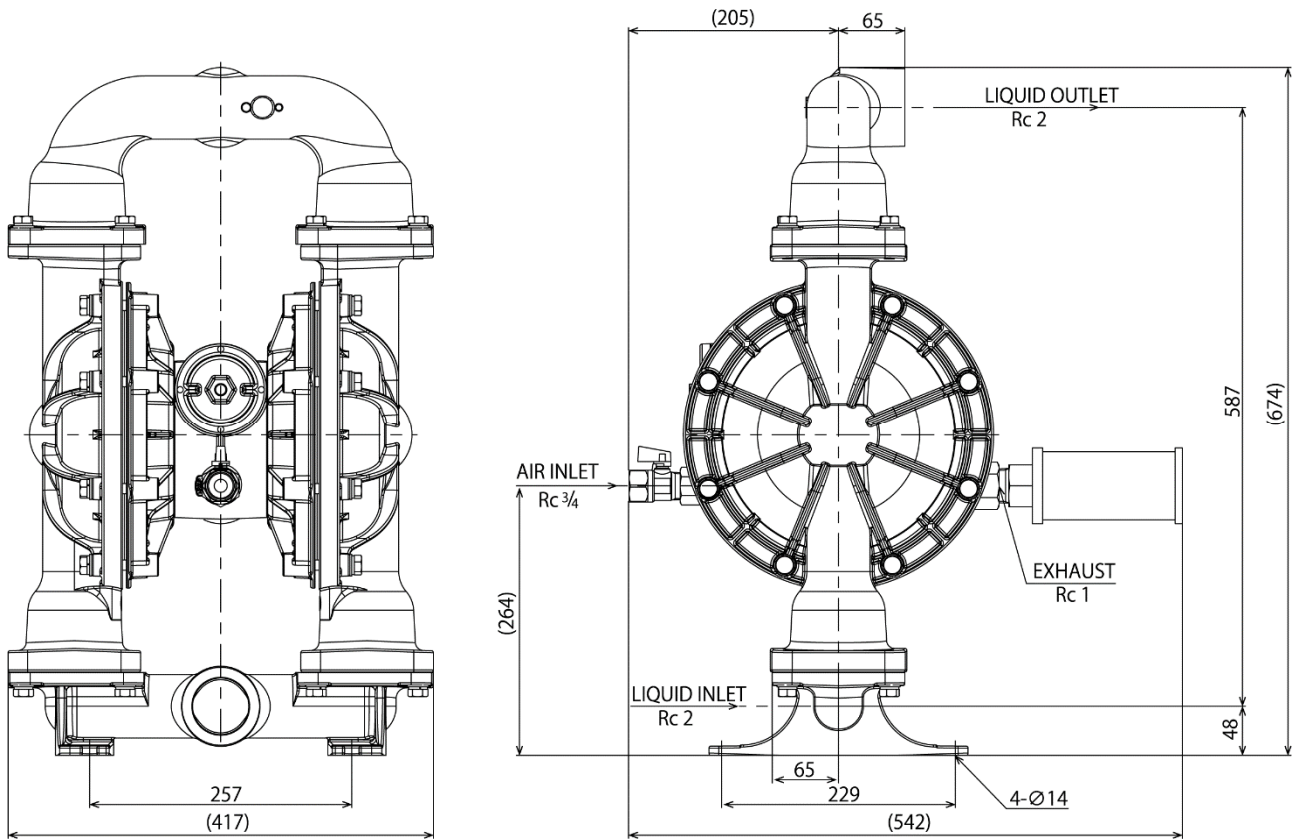

### CAUTION

· Due to improvement or modification of products, dimensions may change without notice.  
Please contact your distributor or regional office for detailed information.

### 10.3 Performance curve

#### ■ G50A\_

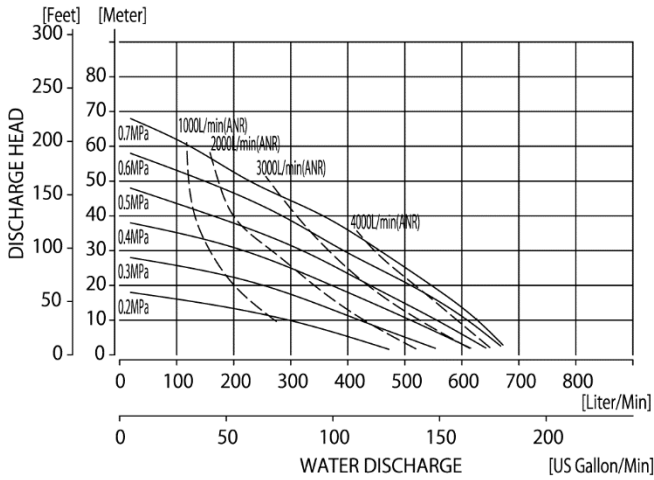

#### ■ G50AT

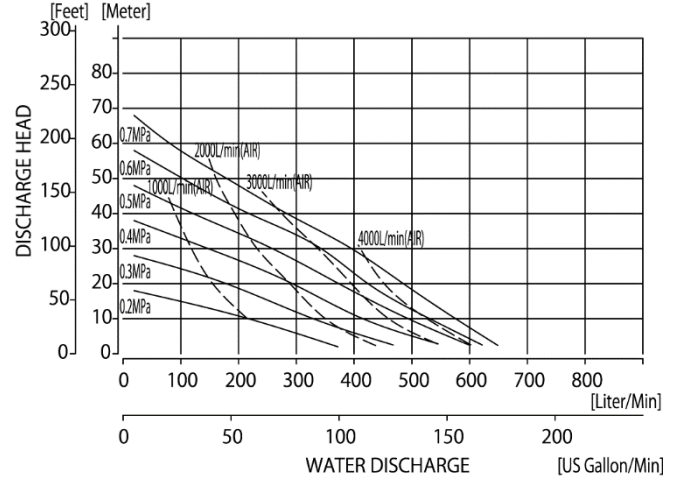

### NOTE: Method of measurement of performance curve

Measuring instruments and procedure

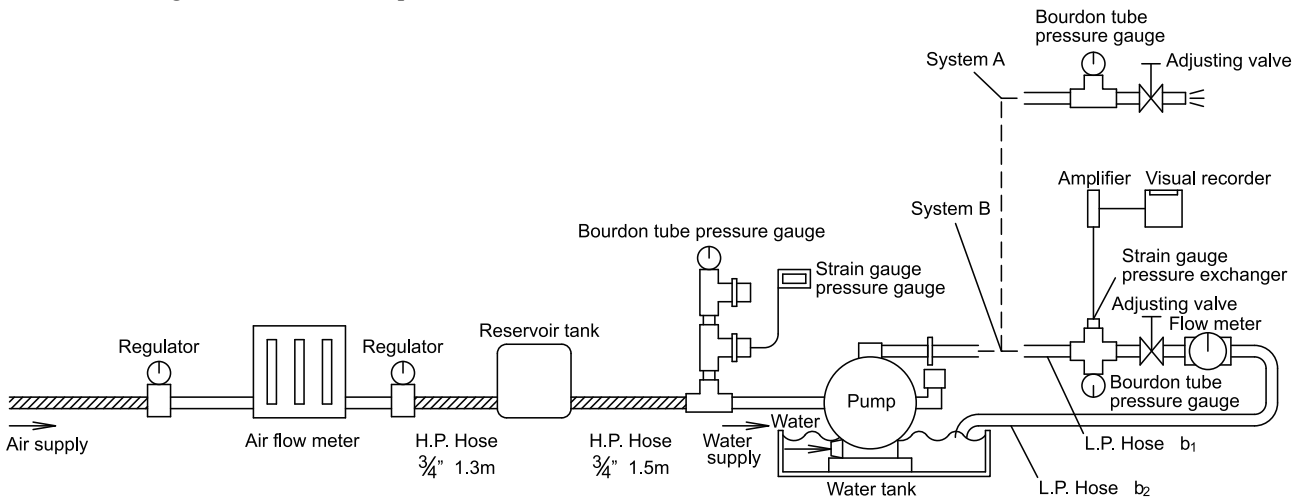

Fig.10.1

#### ▪ Conditions

- a) Supplied air pressure: Maintaining preset pressure
- b) Liquid pumped: Fresh water
- c) Temperature: Ambient
- d) Condition of suction: Flat suction 0 meter head
- e) Measuring system: System A ..... Converting weight of discharged fluid to volume.  
System B ..... By liquid meter

## 11. Limited warranty

If an abnormality occurs during normal operation in accordance with the operating instructions and other operating cautions within the warranty period (12 months after date of purchase) that can be attributed to a manufacturing defect, the defective parts of this product will be serviced or the product will be replaced free of charge. However, this warranty will not cover compensation for incidental damage or any malfunction listed below.

### 1. Warranty period

This warranty will be valid for a period of 12 months after the date of purchase.

### 2. Warranty

If, during the warranty period, any of the material of the genuine parts of this product or the workmanship of this product is found defective, and is so verified by our company, the servicing cost will be fully born by our company.

### 3. Exclusion

Even during the warranty period, this warranty does not cover the following.

- (1) Malfunction arising from use of parts other than manufacturer-specified genuine parts
- (2) Malfunction arising from misuse or operating errors, or lack of storage or maintenance care
- (3) Malfunction arising from use with a fluid that may cause corrosion, inflation or dissolution of the component parts of the product
- (4) Irregularity arising from repair made by other than by our firm, our regional office, dealer or authorized service personnel
- (5) Malfunction arising from modification of the product by other than authorized service personnel
- (6) Wear and tear of parts that must be regularly replaced in the course of normal operation, such as diaphragms, center disk, valve seats, balls/flat valve, air switch sleeve valves, pilot valve, O-rings and gasket.
- (7) Malfunction and/or damage due to use with incorrect voltage.
- (8) Malfunction and/or damage due to transportation, moving or drop page of the product after purchase
- (9) Malfunction and/or damage due to fire, earthquake, flood or other force majeure
- (10) Malfunction arising from use of compressed air that contains impurities or excessive moisture or use of gases or fluids other than the specified compressed air
- (11) Malfunction arising from use of excessively abrasive material or of inadequate grease.







Furthermore, this warranty does not cover the rubber parts, or other parts used in this product and its accessories, which are subject to wear in normal operation.

- hoses
- packings
- cords

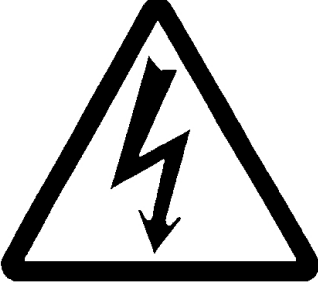
### 4. Parts

Parts for this product will be kept available for 5 years after discontinuation of production. Once 5 years have elapsed after close of production, availability of parts for this product cannot be guaranteed.

## 12. Warning symbols

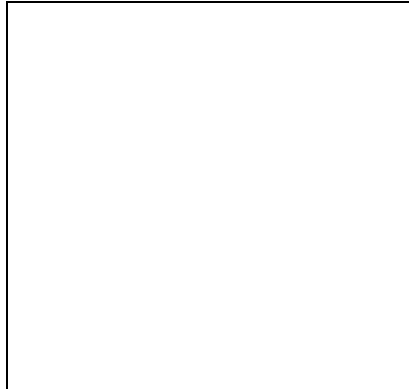
<p>BEWARE: TEMPERATURE</p> <p>HIGH</p> 	<p>ELECTRIC SHOCK</p> 	<p>POISON</p> 
<p>FLAMMABLE</p> 	<p>CORROSION</p> 	<p>EXPLOSION</p> 
<p>General warnings, cautions and danger notifications</p> 	<p>FIRE STRICTLY PROHIBITED</p> 	



## **YAMADA CORPORATION**

### **INTERNATIONAL DEPARTMENT**

1-1-3, Minami-Magome, Ota ku, Tokyo, 143-8504, Japan

PHONE : +81-(0)3-3777-0241

FAX : +81-(0)3-3777-0584

E-mail : intl@yamadacorp.co.jp

Web : www.yamadacorp.co.jp

## **YAMADA (THAILAND) CO., LTD**

41/79 Moo 6, Bangcha-long, Bangplee, Sumutprakarn 10540, Thailand

PHONE : +66-(0)2-130-0990

FAX : +66-(0)2-130-0993

E-mail : sales@yamada-th.com