

Original Instructions **CE**



OPERATION MANUAL

GREASE PUMP

PD110A50T	ITEM No.851728
PD110A50	ITEM No.851779
DR110A50	ITEM No.851783
PD110A50T-SL	ITEM No.851999

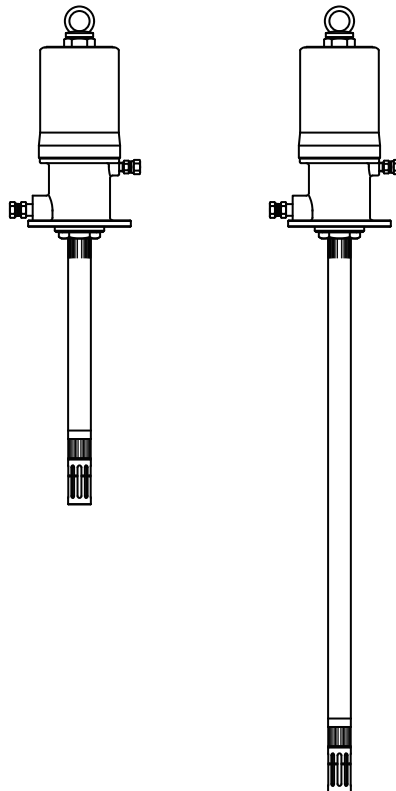

WARNING

Prior to operating this pump, be sure to read this operation manual for safety. After reading the manual, please keep it at hand any time for your quick reference.

YAMADA CORPORATION

EC DECLARATION OF CONFORMITY

Name of company : YAMADA CORPORATION

Address : 1-1-3, Minami-Magome, Ota ku, Tokyo, 143-8504 Japan

declares, in sole responsibility, that the following product

Equipment : GREASE PUMP

Type : DR110A50 and PD110A50T series

Serial Number : Described on the last page of this instruction manual

Referred to in this declaration conforms with the following standard(s) or directive(s) :

- Directive 2006/42/EC
- EN-ISO 12100:2010
- EN 809:1998 + A1:2009

YAMADA CORPORATION will keep on file for review the following technical documentation :

- operating instructions as required
- plans
- description of measures designed to ensure conformity
- other technical documentation

Importer / Distributor in EU

Name of company : YAMADA EUROPE B.V.

Atsushi Yamaguchi (Managing Director)

Address : Aquamarijnstraat 50, 7554 NS Hengelo (0), The Netherlands

Place and date issued : Sagamihara Factory / December 16, 2019

Name and signature as well as position of undersigned :

Kotaro Yamada (Director, Sagamihara Factory)

CE



- Preface

Thank you very much for purchasing Yamada Pump.

- This 110 type pump is a grease pressure-feed pump.
- In the normal operating condition, the pump permits using up to NLGI No.3 grease. When the pump is operated in a very cold or low-temperature environment, the discharge volume is remarkably lowered. In such a case, we shall not guarantee the discharge volume of the pump.
- Silicone grease is not applicable. (PD-110A50T-SL is excluded.)

- For Safe Operation

This manual describes the items that are important for the user to operate this product safely, correctly, and efficiently. Before operating this product, read this manual thoroughly, in particular, “Warnings and Cautions” at the beginning of this manual.

- Warnings and Cautions

For safe use of this product, be sure to note the following: In this document, warnings and cautions are indicated by symbols. These symbols are for those who will operate this product and for those who will be nearby, for safe operation and for prevention of personal injury and property damage. The following warning and caution symbols have the meanings described below. Be sure to remember their meanings.



WARNING:

This indicates the existence of potential hazard which, if not avoided, will result in death or serious injury.



CAUTION :

This indicates the existence of potential hazard which, if not avoided, may result in bodily injury or in physical damage.

Furthermore, to indicate the type of danger and damage, the following symbols are also used along with those mentioned above:



This symbol indicates an act that is prohibited (prohibition). The concrete contents of prohibition are indicated by the side of the indication.

















This symbol indicates the contents that must be observed. The concrete contents of observance are indicated by the side of the indication.

- Precautions on Use

The following warnings and cautions are very important. Be sure to observe them.

WARNING

-  - Keep your face away from the exhaust and discharge ports. Material may suddenly come out. There is a possibility of losing eyesight if it strikes eyes.
-  - Gasoline is a high volatile fuel. Do not use it to clean the pump in any case, otherwise ignition or explosion may be caused.
-  - Keep your fingers away from each port to avoid injury from moving parts.
-  - Modification of this pump may lead to death, bodily injury, or a failure. Do not modify it in any case because it involves a risk.
-  - Keep your hands away from shovel(the lowest part of the pump). During operation to avoid hand injury resulting from being caught in shovel.
-  - The operator and maintenance engineer should read the operation manual thoroughly before operating the pump and performing maintenance in respect of this pump.
-  - Always wear proper safety equipments(facemask, ear plugs, and safety shoes, etc.) when installing, operating and disassembling the pump.
-  - Make ground connection when working with flammable material or in explosive atmosphere. Rapid pumping of material can result in static electrical charge. Also, be sure to provide proper ventilation where a flammable atmosphere may exist.
-  - Execute the daily checkup.
-  - Use this pump according to the product specification.
-  - Attach a valve(for stop in emergency) or regulator to the air supply pipe to keep supply air pressure under 0.7 MPa.
-  - Discontinue it when you feel a hazard or abnormality during the work. And correspond according to the troubleshooting.
-  - Stop pump operation immediately when a drum becomes empty. Running the pump dry will cause excessive vibration, resulting in reduction of pump life and damage to other equipment.
-  - Before maintenance operation, be sure to stop air from being supplied to the pump, and release the internal pressure (both air and material) of the pump. There is danger such as spouting of the material when the maintenance work is done with air supplied.
-  - Do not discharge material directly onto the ground. Dispose of harmful materials according to the requirements specified in SDS or local regulations. Also, dispose of pump according to the local regulations after removing residual material from inside pump. (Please contact industrial waste disposal service.)

 **CAUTION**

- Keep hands and fingers away from the pump during operation to avoid injury from moving parts.



- Use pump for the material suitable for the specification. Parts may be corroded and material leak from the damaged parts can lead to environmental pollution. Also, follow handling notes (SDS) of the manufacturer about the handling of the material used.



- Take fall-prevention measures if using a slim or light tank. Risk of falling will be increased due to shift in center of gravity caused by change in the material level in a tank.



- Take protective measures against rainwater and dust. It is likely to lead to the pollution of the material.



- Be very careful about the edge of the pump when you lift the pump. Your hands might be injured.



- Be very careful about your posture when installing the pump. Back injury may be caused by lifting the pump.



- Do not touch the surfaces of the pump and the hose when pumping high-temperature material. Risk of burns exists.



- Stop the air supply source after the end of work when not using this pump for a long time such as nighttimes and holidays. Also, open the valve of the exhalation port and liberate pressure in the pump and the hose. There is a possibility of polluting facilities because of the damage of the hose and the leakage of the valve. Such a secondary disaster becomes a responsibility on the user side.



- Place a drum on a flat, level surface to position pump horizontally against a ground. Operating the pump on a slope may cause a fall or tip-over due to shift in center of gravity caused by change in the material level.



- Material remaining inside or on the surface of the pump may spill out by inserting or removing the pump into/from a drum. Be very careful not to get your clothing dirty.

Table of Contents

- Preface	
- For Safe Operation	
- Warnings and Cautions	
- Precautions on Use	
1. Names and Materials of Parts	
1.1 Names and Materials of Parts	1
1.2 Contents of Package	1
2. Principles of Operation	1
3. Preparations before Operation	2
3.1 Connecting the ground wire	2
4. How to Operate the Pump	3
5. Maintenance and Inspection	
5.1 Troubleshooting and Corrective Measures	4
5.2 Maintenance and Inspection	5
6. Pump Specifications	6
7. Limited Warranty	7

1. Names and Materials of Parts

1.1 Names and Materials of Parts

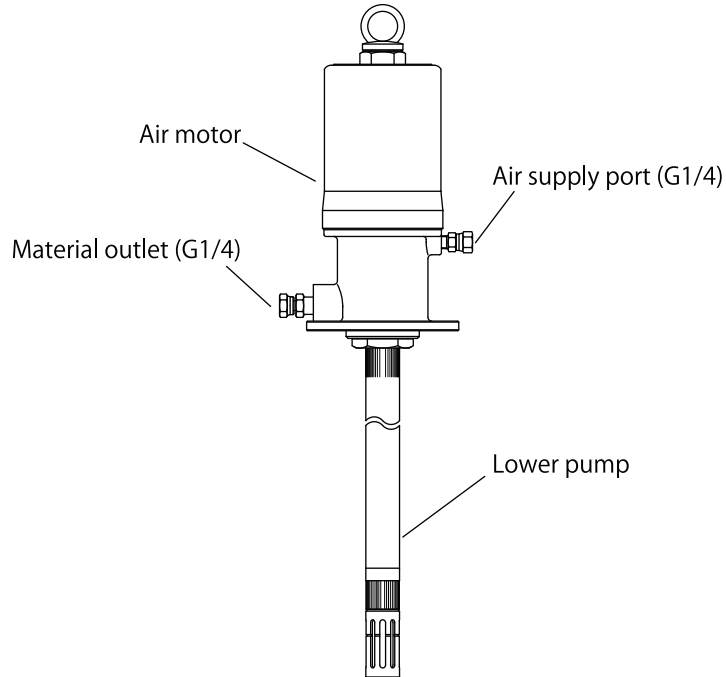

1.2 Contents of Package

Please make sure no damage during shipment and no missing accessories after unpacking as soon as possible.

Please make sure no loose screws, piping connections, and fastener components.

Please retighten if any screws, piping connections, and fastener components are loose.

2. Principles of Operation

The Yamada Air-powered Pump is a reciprocating type that is driven by compressed air. The pump consists of an air motor to drive the pump and a lower pump to draw up the material as shown in the figure at right.

When compressed air is supplied from the compressor to the air motor, the air piston starts its up/down motion by the function of the air switching mechanism built in it. This motion is transmitted to the piston of the lower pump by the connecting rod that connects between the air piston of the air motor and the piston of the lower pump, thereby giving the up/down motion to it. When the up/down reciprocating motion of the piston of the lower pump is performed, the material is sucked into the lower pump and fed out from the discharge port by pressure.

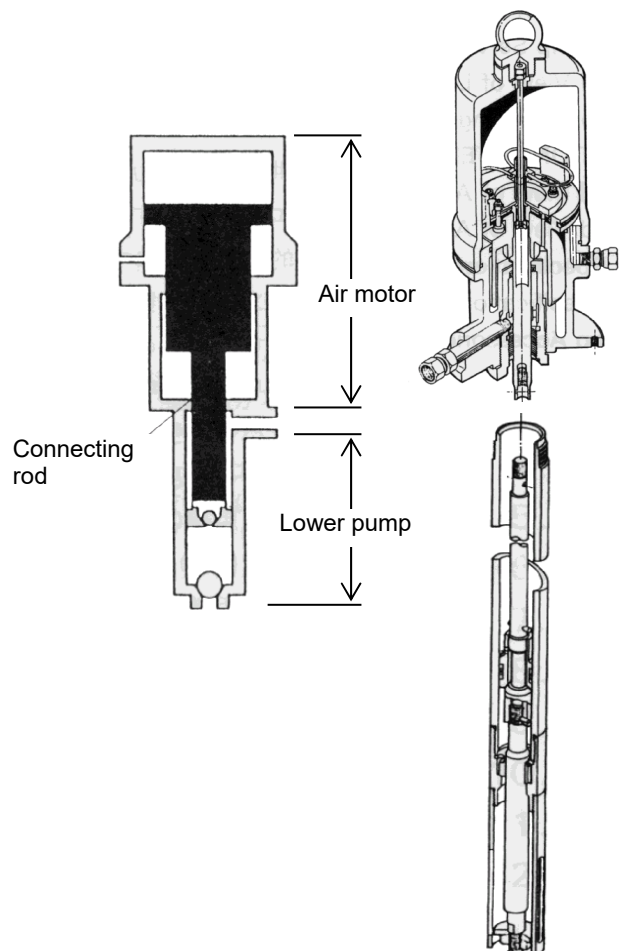

3. Preparations before Operation

CAUTION



- Apply sealing compound or sealing tapes to the male screws and tighten tightly when the pipes are connected.
Be careful not to allow the sealing materials to enter the piping.
Do not apply the tip of the terminal (two thread ridges) to maintain conductive property of the ground.
(However, no applying is necessary if it will be connected to the hose union.)
Check that there is no leakage or electrical continuity in each part after connecting the piping.

* This pump is used in an assembled status as a grease pressure-feed unit except when it is used for a special plant. For the relevant operating method and precautions on handling, see the operation manual attached to the respective product.

* For using the pump independently

1. Install the air regulator (separately available) and the air hose (separately available) at the air supply port.
2. Install the material hose (separately available), grease gun, and high-pressure valve fit for the application at the material discharge port.

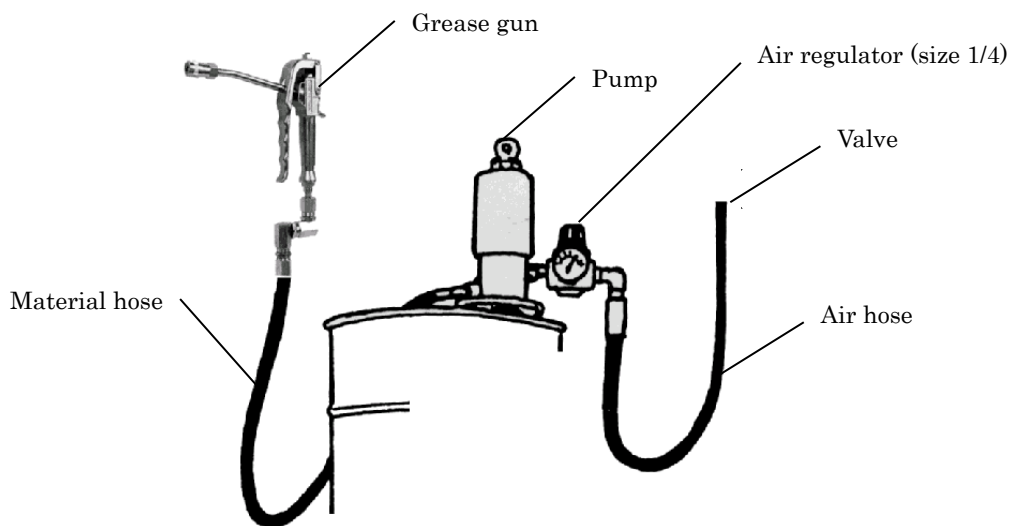

3.1 Connecting the ground wire

WARNING



- Make ground connection when working with flammable material or in explosive atmosphere. Rapid pumping of material can result in static electrical charge. Also, be sure to provide proper ventilation where a flammable atmosphere may exist.



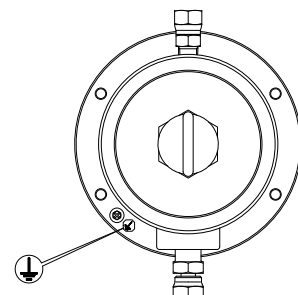

- 1) When installing the pump, be sure to connect the ground wire at the specified position.
- 2) Also connect ground wires to peripheral equipment and piping.
- 3) Use 2.0 mm² minimum ground wire.



Position for connecting the ground wire

4. How to Operate the Pump

WARNING

-  - The supply air pressure to the pump should be 0.7 MPa or less. Do not raise the pressure over 0.7 MPa in any case.
-  - Never bring the face close to the exhaust port of the pump that is in operation. The material is discharged under high pressure, so water may congeal and injury may be caused by ice.
-  - If the air supplied to the pump is not shut off after completion of the work or at night, the hose may be damaged or leak may occur on the valve or gun, thereby causing a secondary accident. This secondary accident shall be attributable the user's responsibility.
-  - If the pump goes to a malfunction or into an operation stop status, do not disassemble the pump carelessly but refer to the item pertaining to "Troubleshooting and Corrective Measures". Judge the status properly and do not disassemble any component other than the component that needs to be assembled.

<NOTE>

- After completion of the work or when the pump is not operated for a long time, shut off the air to stop the supply air to the pump and open the discharge port valve to reduce the internal pressure of the pump and hose.
 - If the grease in the drum can has been exhausted, the pump is operated at a higher speed without grease and has an adverse effect on its life. Stop the pump operation at once and replace the drum can with a new one.
1. Turn the knob of the air regulator clockwise to supply air into the pump. When the supply air pressure reaches 0.15 - 0.2 MPa, the pump starts to operate. The supply air pressure is indicated by the pointer of the pressure gauge.
 2. When air is supplied, the pump is operated for a while to fill the hose, pipe, and gun with grease, and then stopped automatically.
If the pump is continuously operated without stop, leak may have occurred in any connecting portion of the hose, pipe or gun. Stop the air supply and make a check.
 3. Grease is discharged by operating the gun lever at the end of the material hose. When the lever is pulled, the valve is opened and the pump is automatically operated to discharge grease.
When the lever is reset, the valve is closed to stop the grease discharge and the pump is also stopped.
 4. Adjust the supply air pressure according to the application. Usually, the operating pressure should be 0.3 - 0.5 MPa. In particular, when the pump is used for feeding grease, the discharge volume differs depending on the piping length and grease viscosity. Adjust the supply air pressure to your desired level.
 5. After completion of the work, be sure to stop the supply air to the pump.

5. Maintenance and Inspection

5.1 Troubleshooting and Corrective Measures

If the pump operation becomes unstable or trouble is caused to its grease discharge during operation, make a check according to the following procedure.

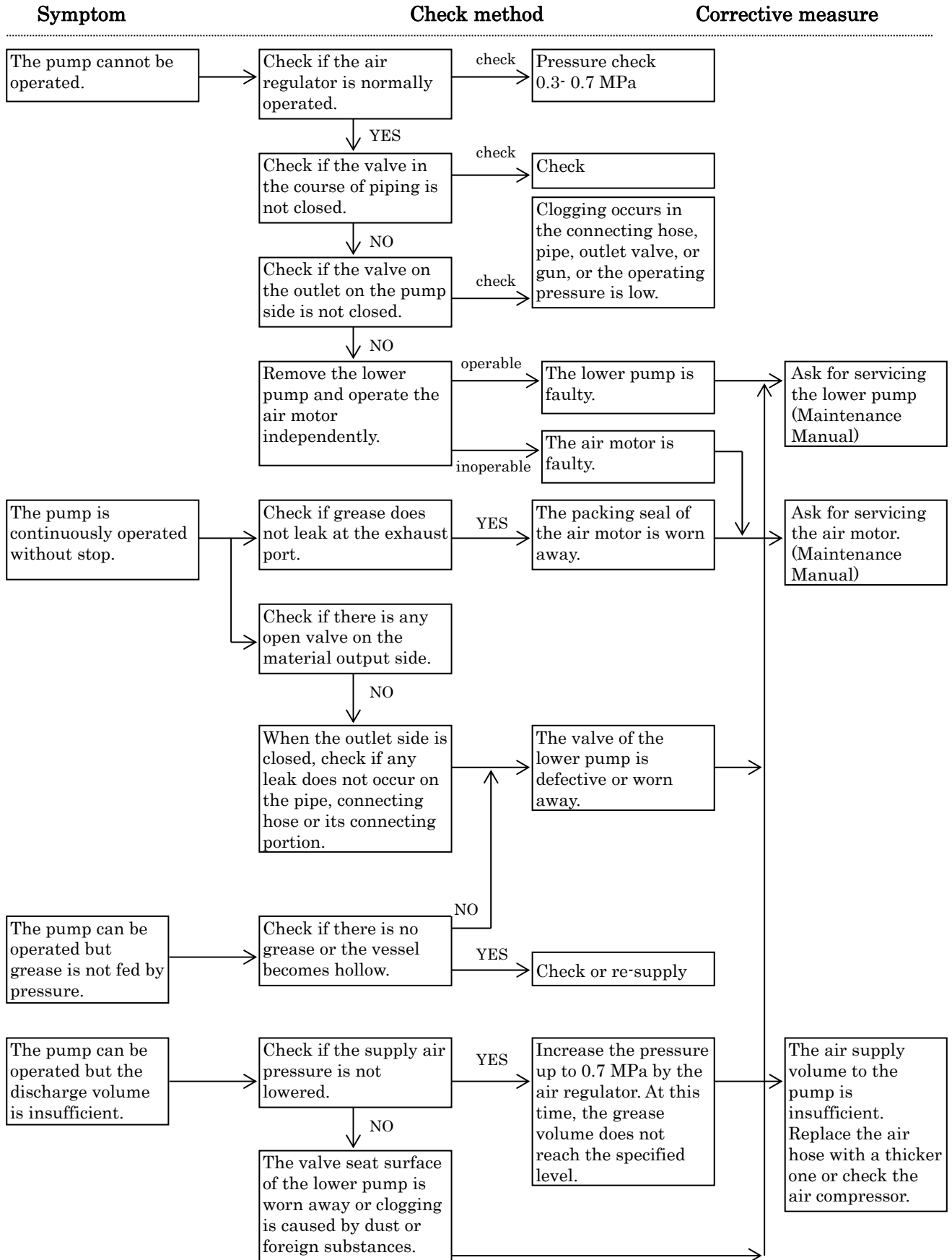

5.2 Maintenance and Inspection

■Oiling

For lubrication of the pump, perform oiling once every 10 days with lubricating oil.

Supply the lubricating oil as following.

1. Remove the air regulator.
2. Inject a few drops of lubricating oil (approx. 0.5 ml) into the air supply port a few drops of lubricating oil (approx. 0.5 ml) into the air supply port as shown in the figure at right. Use turbine oil class 1 ISO (VG-32) or equivalent as the lubricating oil.

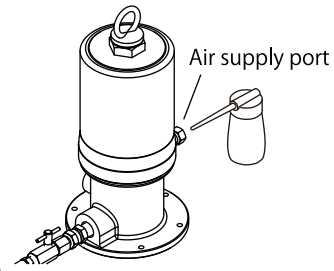

■Inspection

The parts used in the packing and slide portion of the pump will be worn away. They must be checked and replaced once a year. See the separate Maintenance Manual.

6. Pump Specifications

■Engineering Data

TYPE		PD110A50T	PD110A50	DR110A50	PD110A50T-SL
MODEL No.		851728	851779	851783	851999
PUMP RATIO (NOMINAL)		50 x 1			
FLUID CONNECTION	SUCTION PORT	Suction port has mounting grooves for a special inductor plate.			
	DISCHARGE PORT	G 1/4 (F) (Union adapter)			
AIR CONNECTION	SUPPLY PORT	G 1/4 (F) (Union adapter)			
	EXHAUST PORT	G 3/4 (F) (Female thread covered by a muffler.)			
OPERATING AIR PRESSURE		0.3 - 0.7 MPa			
MAXIMUM OPERATING NOISE	A-WEIGHTED SOUND PRESSURE LEVEL *1	80 dB			
	A-WEIGHTED SOUND POWER LEVEL *2	92 dB			
AMB. TEMP. RANGE	TEMP. AMBIENT	0 - 60 °C			
	TEMP. MATERIAL	0 - 80 °C			
STROKE (NOMINAL)		60 mm			
DISCHARGE VOLUME per CYCLE *3		11.0 mL			
MAXIMUM DISCHARGE PRESSURE		35 MPa			
WEIGHT		8.6 kg	9.2 kg	11.0 kg	8.6 kg

*1 Measurement method of A-weighted sound pressure level is based on ISO 1996.

*2 Measurement method of A-weighted sound power level is based on ISO 3744.

*3 Discharge volume (per cycle) varies according to use conditions.

■Performance Curve

NOTE

The continuous pump operation should be avoided if the desired delivery is in the range shaded in the figure below.

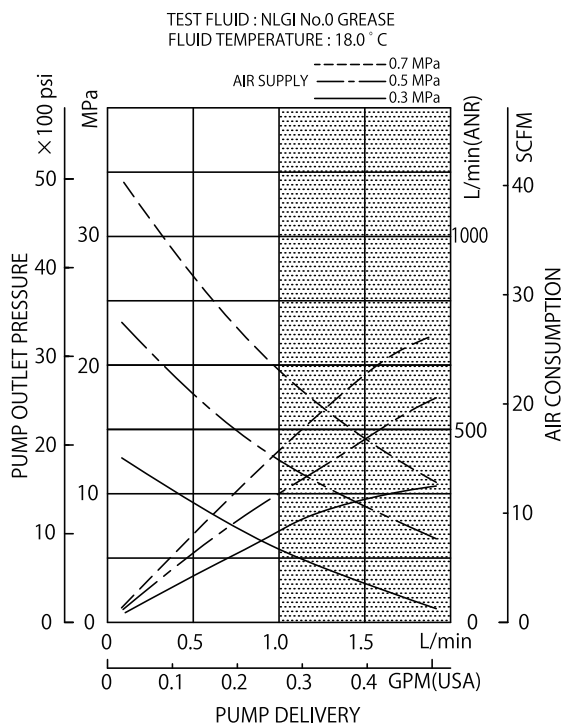

■Dimensions

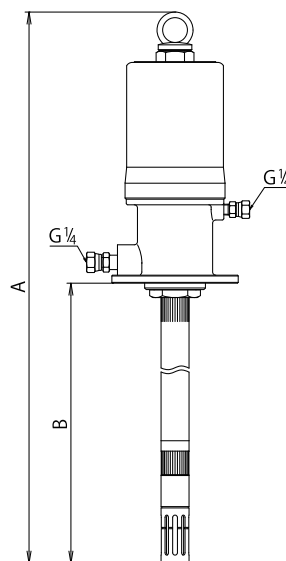
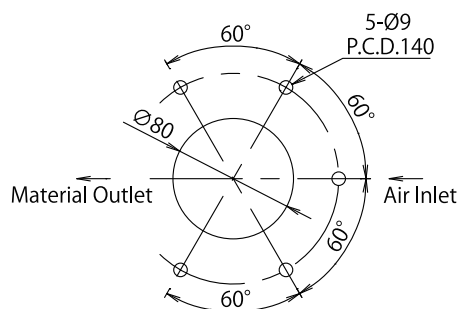

Item No.	A (mm)	B (mm)
851728	767	427
851999	867	527
851779	1210	870

7. Limited Warranty

If an abnormality occurs during normal operation in accordance with the operating instructions and other operating cautions within the warranty period (12 months after date of purchase) that can be attributed to a manufacturing defect, the defective parts of this product will be serviced or the product will be replaced free of charge. However, this warranty will not cover compensation for incidental damage or any malfunction listed below.

1. Warranty period

This warranty will be valid for a period of 12 months after the date of purchase.

2. Warranty

If, during the warranty period, any of the material of the genuine parts of this product or the workmanship of this product is found defective, and is so verified by our company, the servicing cost will be fully born by our company.

3. Exclusion

Even during the warranty period, this warranty does not cover the following.

- 1) Malfunction arising from use of parts other than manufacturer-specified genuine parts
- 2) Malfunction arising from misuse or operating errors, or lack of storage or maintenance care
- 3) Malfunction arising from use with a fluid that may cause corrosion, inflation or dissolution of the component parts of the product
- 4) Irregularity arising from repair made by other than by our firm, our regional office, dealer or authorized service personnel
- 5) Malfunction arising from modification of the product by other than authorized service personnel
- 6) Wear and tear of parts that must be regularly replaced in the course of normal operation, such as packings, O-rings and hose.
- 7) Malfunction and/or damage due to use with incorrect voltage.
- 8) Malfunction and/or damage due to transportation, moving or drop page of the product after purchase
- 9) Malfunction and/or damage due to fire, earthquake, flood or other force majeure
- 10) Malfunction arising from use of compressed air that contains impurities or excessive moisture, or use of gases or fluids other than the specified compressed air
- 11) Malfunction arising from use of excessively abrasive material or of inadequate grease.

Furthermore, this warranty does not cover the rubber parts, or other parts used in this product and its accessories, which are subject to wear in normal operation.

- hoses
- packings
- cords

4. Parts

Parts for this product will be kept available for 5 years after discontinuation of production. Once 5 years have elapsed after close of production, availability of parts for this product cannot be guaranteed.

YAMADA EUROPE B.V.

Aquamarijnstraat 50,7554 NS Hengelo (O),The Netherlands
PHONE : +31-(0)74-242-2032
FAX : +31-(0)74-242-1055
E-mail : sales@yamada.nl
Web : www.yamada-europe.com

Manufactured by

YAMADA CORPORATION

INTERNATIONAL DEPARTMENT
1-1-3, Minami-Magome,Ota ku, Tokyo, 143-8504, Japan
PHONE : +81-(0)3-3777-0241
FAX : +81-(0)3-3777-0584
E-mail : intl@yamadacorp.co.jp
Web : www.yamadacorp.co.jp

202011.2503 APP003U