

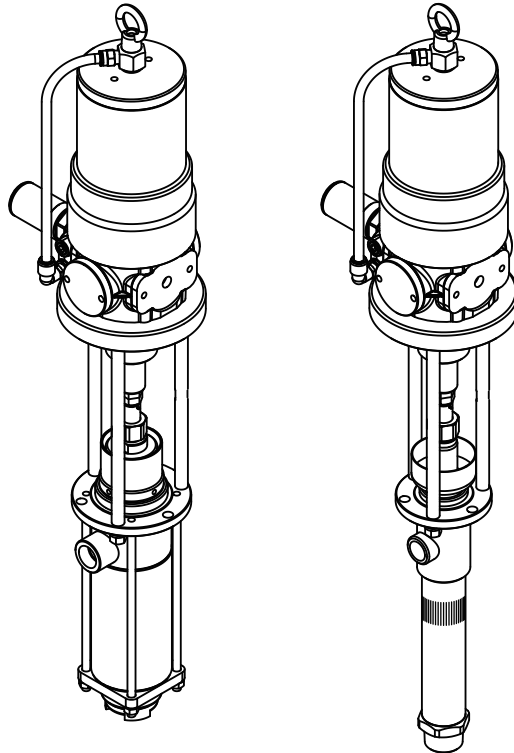

INSTRUCTION

Pump 125 separate type series

SH-125B□	ITEM No.854592·854594·855262 (SIPHON TYPE)
DR-125B□	ITEM No.854593·854595·855263 (DRUM TYPE)
SH-125B□-V	ITEM No.854598·854600 (SIPHON TYPE -V)
DR-125B□-V	ITEM No.854599·854601 (DRUM TYPE -V)



WARNING

Prior to operating this pump, be sure to read this operation manual for safety. After reading the manual, please keep it at hand any time for your quick reference.

YAMADA CORPORATION

- Preface

Thank you very much for purchasing Yamada Pump. This pump, driven by the compressed air from an air compressor, is designed to pump out or transfer lubricant from drum cans or other vessels.

125 series pumps are powered by compressed air and designed to transfer low viscosity material such as oil from a drum or other containers.

For transferring solvent (paint, lacquer, thinner etc.), “-V” type pumps in 125 series are available.

- For Safe Operation

This document describes the items that are important for the user to operate this product safely, correctly, and efficiently. Before operating this product, read this manual thoroughly, in particular, “Warnings and Cautions” at the beginning of this manual, with a good understanding of its contents. Keep this manual carefully in an easy-to-access place so that the user may refer to it whenever necessary.

- Warnings and Cautions

For safe use of this product, be sure to note the following: In this document, warnings and cautions are indicated by symbols. These symbols are for those who will operate this product and for those who will be nearby, for safe operation and for prevention of personal injury and property damage. The following warning and caution symbols have the meanings described below. Be sure to remember their meanings.



WARNING : This indicates the existence of potential hazard which, if not avoided, will result in death or serious injury.



CAUTION : This indicates the existence of potential hazard which, if not avoided, may result in bodily injury or in physical damage.

Furthermore, to indicate the type of danger and damage, the following symbols are also used along with those mentioned above:



This symbol indicates an act that is prohibited (prohibition). The concrete contents of prohibition are indicated by the side of the indication.



This symbol indicates the contents that must be observed. The concrete contents of observance are indicated by the side of the indication.

- Precautions on Use

The following warnings and cautions are very important. Be sure to observe them.

WARNING

[Operating condition]



- Restriction on handling
Never let anyone operate this unit without understanding this manual.



- Read this manual thoroughly before use.
For your safety, read and understand all information provided in this manual.
If you have lost or damaged your instruction manual, please contact us or our distributor to place an order.

[Operating method]



- Keep your face away from the exhaust and discharge ports.
Material may suddenly come out. There is a possibility of losing eyesight if it strikes eyes.



- Connecting ports
Keep your fingers away from each port to avoid injury from moving parts.



- Understand this manual completely before operating the machine.
The operator and maintenance engineer should read the operation manual thoroughly before operating the pump and performing maintenance in respect of this pump.



- Do not use inappropriately.
Use of the product for any purpose other than those specified in this manual may result in personal injury or property damage.
Be sure to use the unit in accordance with the specifications in this manual.



- Wear proper safety equipments.
Always wear proper safety equipments (facemask, ear plugs, and safety shoes, etc.) when installing, operating, and disassembling the pump.



- Ground connection
Make ground connection to pump and peripheral equipment. Rapid pumping of material can result in static electrical charge. Also, be sure to provide proper ventilation where a flammable atmosphere may exist.



- In case of abnormality
If there is any danger or abnormality, discontinue pump operation and refer to Troubleshooting to solve the problem.



- Do not run the pump dry.
Stop pump operation immediately when a drum becomes empty. Running the pump dry will cause excessive vibration. Be especially careful when pumping explosive material. Mixture of an air and vaporized material can explode. If there is any possibility of running dry, install a dry-run protection device like a liquid level control. Be sure to install a vibration reduction device to reduce vibration, resulting in reduction of pump life and damage to other equipment.

[Installation and piping]



- Air supply pipe
Attach a valve (for stop in emergency) or regulator to the air supply pipe to keep supply air pressure under 0.7 MPa.



- Check strength of mounting surface.
(SH type only) If using a wall mount bracket for installation, the must be strong enough to withstand vibration of the pump.

[Disassembly, maintenance and inspection]



- No alternation is permitted.
Alternating the unit may result in personal injury or product malfunction. Please do not try to alter, modify, or change the machine.



- Never use gasoline or any other volatile material.
Gasoline is a high volatile fuel. Never use for cleaning of the unit in any case. Risk of fire or explosion may exist.

WARNING



- Some materials can be detrimental to the environment.
Do not discharge material directly onto the ground. Dispose of harmful materials according to the requirements specified in SDS or local regulations. Also, dispose of pump according to the local regulations after removing residual material from inside pump. (Please contact industrial waste disposal service.)



- Daily checkup
Execute the daily checkup.



- Shut off air supply.
Before maintenance involving disassembly, be sure to shut off air supply to the pump and release residual air pressure and material pressure in the tubes and pump. Failure to do so may result in material gushing out.



- Replacement time for consumables
The life of consumables varies depending on operating conditions. Replace a degraded part with a new one.

CAUTION

[Installation and piping]



- Install an emergency stop valve.
Attach an emergency stop valve to the air piping (somewhere accessible between the air source and unit) and close this valve in case of emergency.



- Stop operation.
If any abnormality is found during operation, immediately stop the machine. Do not restart until the cause has been identified and corrected.



- Shut off air supply.
Shut off the air source before installation and piping.



- Install properly.
Install the unit properly according to the requirements for location and material, pressure resistance, and size of hoses and other device, avoiding lift operation failure and pipe leakage or breakage.



- Measures against rainwater and dust
Take protective measures against rainwater and dust. It is likely to lead to the pollution of the material.



- When installing the pump
Be very careful about your posture when installing the pump. Back injury may be caused by lifting the pump. Be very careful about the edge of the pump when you lift the pump. Your hands might be injured.



- When installing the drum
(DR type only) Place a drum on a flat, level surface to position pump horizontally against a ground. Operating the pump on a slope may cause a fall or tip-over due to shift in center of gravity caused by change in the material level.



- Do not plumb directly.
Do not connect the material outlet and piping directly. Attach a flexible tube like a hose to connect the pump to the piping. The pump, if connected directly to the piping, may cause many problems (e.g., noise caused by vibration, damage to the piping, operation failure of the lift, and failure of maintenance).

 **CAUTION**

[Handling]



- Keep hands and fingers away from the pump during operation.
Keep hands and fingers away from the pump during operation to avoid injury from moving parts.
Do not touch the surfaces of the pump and the hose when pumping high-temperature material. Risk of burns exists.



- In case of emergency
In case of emergency, close emergency stop valve



- Maximum operating pressure of the pump
Do not exceed the maximum operating pressure of the pump (0.7 MPa).



- Material
Use pump for the material suitable for the specification. Parts may be corroded and material leak from the damaged parts can lead to environmental pollution. Also, follow handling notes (SDS) of the manufacturer about the handling of the material used.



- Fall-prevention measures
Take fall-prevention measures if using a slim or light tank. Risk of falling will be increased due to shift in center of gravity caused by change in the material level in a tank.
When using a bung adapter, to prevent the pump from falling over, hang the pump with a crane etc.



- When Replacing drum
(DR type only) Material remaining inside or on the surface of the pump may spill out by inserting or removing the pump into from a drum. Be very careful not to get your clothing dirty.

[Shutdown and storage]



- When left unused for a long time (an week or more) or shutdown
Shut off air source after work and nighttime, holidays, or when the pump is not in use for a while. Also, open the valve at the discharge port to release residual pressure in the pump and hoses. Failure to do so may result in damage to the hoses or facility pollution due to leak from the valve. The use has a responsibility for such secondary accidents.

Table of Contents

- Preface	
- For Safe Operation	
- Warnings and Cautions	
- Precautions on Use	
- Table of Contents	
1. Part Names	
1.1 Part names	1
1.2 Contents of a package	1
2. Operating principle	1
3. Preparation of Installation and Operation	2
3.1 Pump installation	3
3.2 Installation of drum pump (Using a drum cover)	3
3.3 Installation of drum pump (Using a bung adapter)	3
3.4 Installation of siphon pump	4
3.5 Installation of nylon tube	4
3.6 Installation of silencer	4
3.7 Connecting the ground wire	4
3.8 Discharge piping	5
3.9 Air piping	5
3.10 Preparation for use	5
4. Operating Method	6
4.1 Operation switch and valve	7
4.2 Solvent cup	8
4.3 Filling delivery piping with material	8
4.4 Operation	8
4.5 Retightening gland packing	8
4.6 When container is empty (changing drum)	8
4.7 After work	8
5. Maintenance and Inspection	9
5.1 Maintenance and Inspection	10
5.2 Troubleshooting	11
5.3 Consumable	12
5.4 Design standard use period	13
6. Parts Disassembly Drawing and Parts List	13
7. Specifications	18
8. Limited Warranty	21

1. Part Names

1.1 Part names

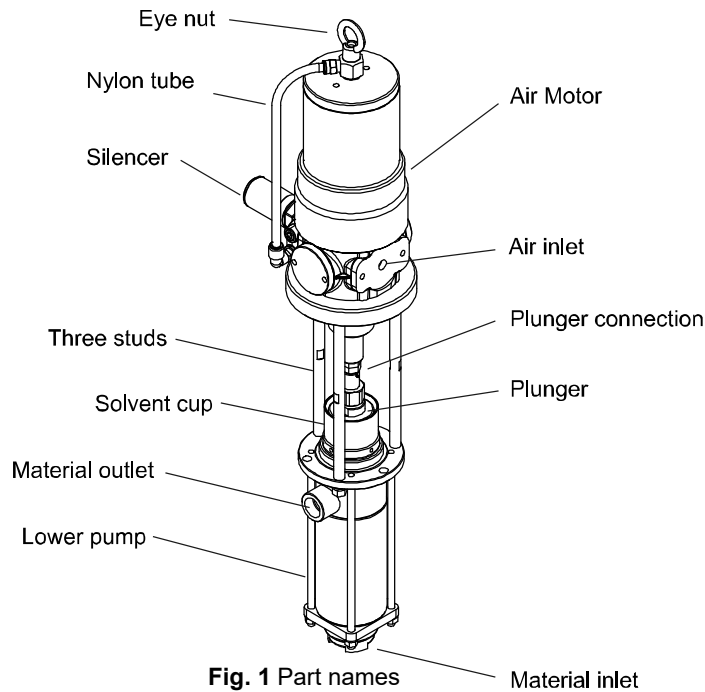

Fig. 1 Part names

1.2 Contents of a package

The unit is packed in a wooden box.
Please make sure no damage during shipment and no missing accessories after unpacking as soon as possible.
Please make sure no loose screws, piping connections, and fastener components.
Please retighten if any screws, piping connections, and fastener components are loose.
(The nylon tube and the silencer are detached from the pump in the packaging due to the shipping conditions.)

2. Operating Principle

Yamada's air-powered pumps employ reciprocating motion system driven by compressed air. It is comprised of two sections as illustrated at right; air motor section which drives the pump and lower pump section which pump up material. When compressed air, generated by the compressor, is fed into the air motor, the air switching mechanism built in the air piston actuates vertical reciprocating motions. The connecting rod, joining the air piston inside the air motor and the piston inside the lower pump, transmits the movement to the piston inside the lower pump, giving vertical reciprocating strokes. Vertical reciprocating motions, generated by the lower pumps, feed material into the lower pump. Then, it is pumped out of the discharge port.

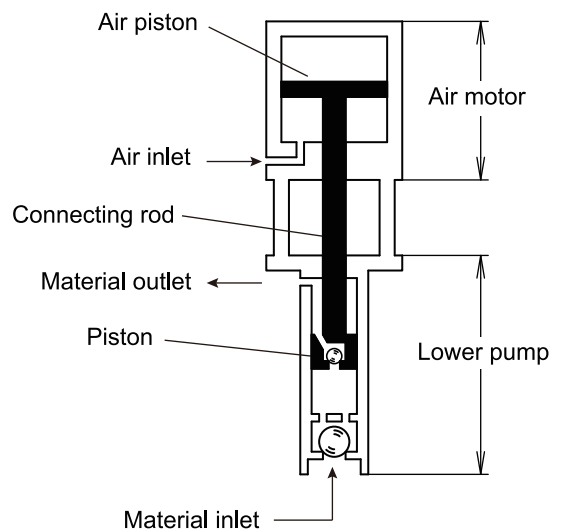



















Fig. 2

3. Preparation of Installation and Operation

WARNING

-  - Keep your fingers away from each port to avoid injury from moving parts
-  - The pump weighs about 30 kg. Be careful not to let the pump fall over or get crushing injury during installation.
-  - Always wear proper safety equipments (facemask, ear plugs, and safety shoes, etc.) when installing, operating, and disassembling the pump.
-  - Make ground connection when working with flammable material or in explosive atmosphere. Rapid pumping of material can result in static electrical charge. Also, be sure to provide proper ventilation where a flammable atmosphere may exist.
-  - Attach a valve (for stop in emergency) or regulator to the air supply pipe to keep supply air pressure under 0.7 MPa.
-  - (SH type only) If using a wall mount bracket for installation, the wall must be strong enough to withstand vibration of the pump.

CAUTION

-  - Keep hands and fingers away from the pump during operation to avoid injury from moving parts. Do not touch the surfaces of the pump and the hose when pumping high-temperature material. Risk of burns exists.
-  - Attach an emergency stop valve to the air pipe (somewhere accessible between the air source and unit), and in case of emergency, close this valve.
-  - If there is any danger or abnormality, discontinue pump operation and refer to Troubleshooting to solve the problem.
-  - Shut off the air source before installation and piping.
-  - When installing the pump, select an appropriate place and suitable piping material, pressure resistance, and size to avoid leakage and damage to the piping.
-  - Take protective measures against rainwater and dust. It is likely to lead to the pollution of the material.
-  - Be very careful about your posture when installing the pump. Back injury may be caused by lifting the pump.
-  - Be very careful about the edge of the pump when you lift the pump. Your hands might be injured.
-  - (DR type only) Place a drum on a flat, level surface to position pump horizontally against a ground. Operating the pump on a slope may cause a fall or tip-over due to shift in center of gravity caused by change in the material level.
-  - Do not directly connect the piping to the pump. Be sure to use a flexible tube like a hose to connect between the pump and piping. Direct connection damages the piping by vibrations when running the pump, causes noises, and in case of the drum pump, makes it impossible to replace the drum can and disables maintenance of the pump.
-  - Take fall-prevention measures if using a slim or light tank. Risk of falling will be increased due to shift in center of gravity caused by change in the material level in a tank.
-  - When using a bung adapter, to prevent the pump from falling over, hang the pump with a crane etc.

⚠ CAUTION



- Apply sealing compound or sealing tapes to the male screws and tighten tightly when the pipes are connected.
- Be careful not to allow the sealing materials to enter the piping.
- Do not apply the tip of the terminal (two thread ridges) to maintain conductive property of the ground. (However, no applying is necessary if it will be connected to the hose union.)
- Check that there is no leakage or electrical continuity in each part after connecting the piping.

3.1 Pump installation

Refer to Fig. 3 for mounting dimensions of the pump. Make sure the environment to install the pump satisfies the following conditions:

- A flat surface indoor (area where exhaust from the pump does not affect peripheral equipment)
- Enough space to perform maintenance

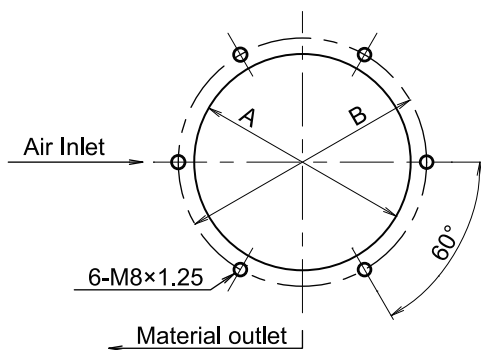

Fig. 3 Pump mounting dimension

	3.5×1 5×1	13×1
A : Dimension of mounting plate	φ 152	φ 122
B : Bolt hole	P.C.D.168	P.C.D.140

3.2 Installation of drum pump

(Using a drum cover: DR-125B3.5, DR-125B5)

- 1) Secure the pump to a drum cover (sold separately) and mount it on an open top drum.
- 2) When installing on a drum, use a crane to lift up the pump with the eye nut on the top.

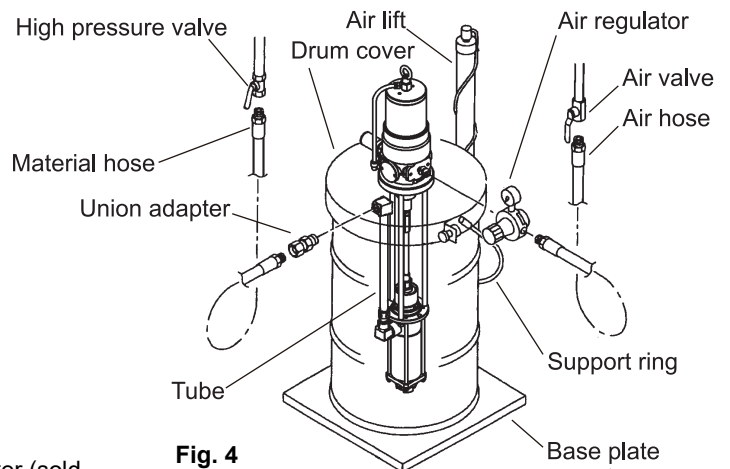

Fig. 4

3.3 Installation of drum pump

(Using a bung adapter: DR-125B13)

- 1) Remove a plug on a drum and attach a bung adapter (sold separately).
- 2) Insert the pump into the bung adapter. Once the lower end (foot valve) reaches the bottom of the drum, lift up the pump 2-3 cm above to make space between the foot valve and the bottom of the drum. Then, secure a wing screw on the bung adapter to set the pump in place.

When installing on a drum, use a crane to lift up the pump with the eye nut on the top.

To prevent the pump from falling over, keep hanging the pump with a crane.

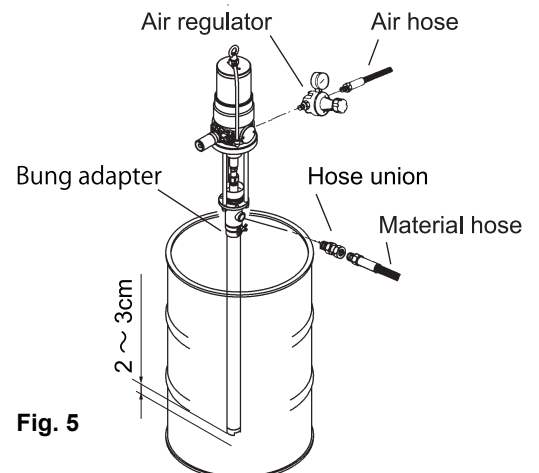

Fig. 5



CAUTION



- When using a closed type drum, loosen a vent plug to avoid creating a vacuum.

3.4 Installation of siphon pump

(Using a wall bracket)

- 1) Attach a wall bracket (sold separately) or a panel unit (sold separately) to the pump. Or secure the pump to a mounting.
- 2) Connect a suction hose assembly (sold separately) to the pump. (Fig. 6)

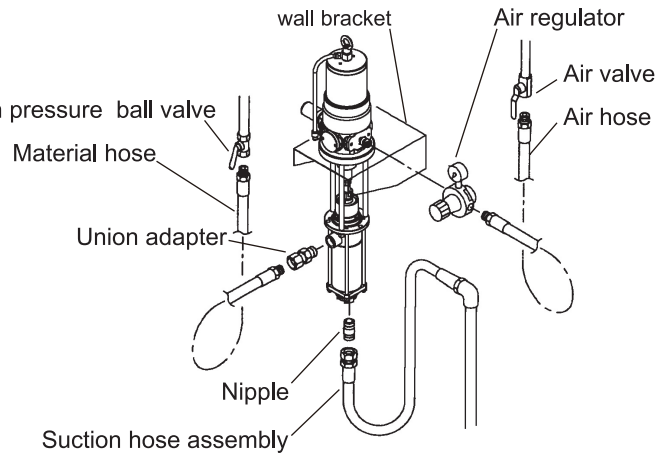

Fig. 6

3.5 Installation of nylon tube

Please correctly install the nylon tube to the pump by referring to Fig. 1 of "1.1 Part Names".

Then please make sure to insert the nylon tube into the fitting as deeply as possible. After the installation, please make sure that the nylon tube is firmly connected by lightly pulling it.

3.6 Installation of silencer

CAUTION
<ul style="list-style-type: none"> - Each connection is capped. Remove the caps all. - Wrap sealing tape around the silencer thread to prevent leakage.

Attach the silencer to the pump and secure it using a tool. (Fig. 7)
Wrap sealing tape around the silencer thread to prevent leakage.

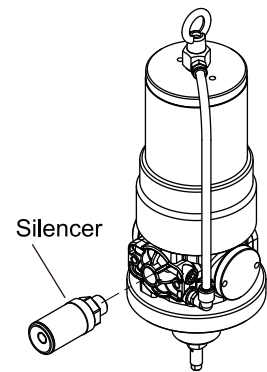

Fig. 7

3.7 Connecting the ground wire

WARNING
<ul style="list-style-type: none"> - Make ground connection when working with flammable material or in explosive atmosphere. Rapid pumping of material can result in static electrical charge. Also, be sure to provide proper ventilation where a flammable atmosphere may exist.

- 1) When installing the pump, be sure to connect the ground wire at the specified position. For the specified position for connecting the ground wire, see "1. Names of parts and materials". (Fig. 8)
- 2) Also connect ground wires to peripheral equipment and piping.
- 3) Use 2.0 mm² minimum ground wire.

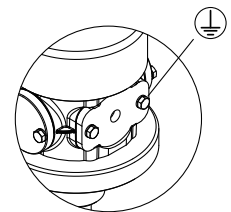

Fig. 8 Position for connecting the ground wire

3.8 Discharge piping

- 1) Connect a discharge hose to the pump outlet. Make sure the hose satisfies the following requirements:
 - Resistant to material being pumped and unaffected by environment
 - Satisfying the following normal operation pressure:
 - 3.5×1 ratio pump : 2.45 MPa or more
 - 5×1 ratio pump : 3.5 MPa or more
 - 13×1 ratio pump : 9.1 MPa or more
 - A flexible hose with an adequate length in order not to be affected by replacing a material container
 - When mounting the pump on an elevating machine like a lift, be sure to use a flexible hose with an adequate length in order not to be affected by up-and-down movement.
 - Recommended size: 1 inch or 3/4 inch or more
 - Hose fitting or joint: Connectable to Rc 1 or Rc 3/4 material outlet
 - A relief valve (required)
- 2) Connect the other end of the hose to a delivery pipeline or oil gun (sold separately). Attach a valve at the connection between the hose and the piping for maintenance and keep it closed until unit installation is completed.





3.9 Air piping

- 1) Connect air piping equipment such as an air valve and air regulator to the air inlet of the pump. Attach an emergency stop valve to the air pipe (somewhere accessible between the air source and unit).
- 2) Select an air supply hose, fitting, and air equipment that satisfy the following requirements. With these devices, connect an air piping and the air inlet. Be careful not to let the hose get caught on peripheral equipment.
 - Designed for use with air and unaffected by environment
 - Normal operation pressure: 0.7 MPa or more
 - Recommended size: 3/8 inch or more
 - A flexible hose
 - Comfortable hose length for up/down movement of the lift
 - Hose fitting or joint: Connectable to Rc3/8 air inlet
 - Flow rate: 1300 L/min (ANR) or more

NOTE

The air regulator controls supply air pressure to the pump. Accordingly, the pump operates efficiently without unnecessary movement and thus the life of the pump can be extended.









3.10 Preparation for use

 WARNING	
	- Gasoline is a high volatile fuel. Do not use it to clean the pump in any case, otherwise ignition or explosion may be caused.
 CAUTION	
	- Following materials are used for packings and O-rings. Please do not use solvent that corrode these when washing pump. <ul style="list-style-type: none">- 3.5x1 and 5x1 pump except “-V” series ... NBR, PTFE- 3.5x1 and 5x1 pump “-V” series FKM, PTFE- 13x1 pump NBR











The pump has been tested using mineral oil before delivery. Please wash inside the pump with appropriate solvent for the material being pumped.

4. Operating Method

WARNING

-  - Keep your face away from the exhaust and discharge ports. Material may suddenly come out. There is a possibility of losing eyesight if it strikes eyes.
-  - Keep your fingers away from each port to avoid injury from moving parts.
-  - Do not discharge material directly onto the ground. Dispose of harmful materials according to the requirements specified in SDS or local regulations. Also, dispose of pump according to the local regulations after removing residual material from inside pump. (Please contact industrial waste disposal service.)
-  - The operator and maintenance engineer should read the operation manual thoroughly before operating the pump and performing maintenance in respect of this pump.
-  - Use of the product for any purpose other than those specified in this manual may result in personal injury or property damage.
Be sure to use the unit in accordance with the "7. Specifications" in this manual.
-  - Always wear proper safety equipments (facemask, ear plugs, and safety shoes, etc.) when installing, operating, and disassembling the pump.
-  - Make ground connection when working with flammable material or in explosive atmosphere. Rapid pumping of material can result in static electrical charge. Also, be sure to provide proper ventilation where a flammable atmosphere may exist.
-  - If there is any danger or abnormality, discontinue pump operation and refer to "5.2 Troubleshooting" to solve the problem.
-  - Stop pump operation immediately when material in a container is all gone. Running the pump dry will cause excessive vibration, resulting in reduction of pump life and damage to other equipment.
Be especially careful when pumping explosive material. Mixture of an air and vaporized material can explode. If there is any possibility of running dry, install a dry-run protection device like a liquid level control.

CAUTION

-  - Do not exceed the maximum operating pressure of the pump (0.7 MPa). Overpressure may cause a product failure resulting in serious personal injury and/or property damage.
-  - In case of a pump malfunction or shutdown, refer to "5.2 Troubleshooting" to judge the situation thoroughly and disassemble the pump only as necessary.
-  - Keep your hand away from the three studs connecting the air motor and lower pump. Fingers can get caught in the reciprocating plunger.
In case of transferring high-temperature material, surface of pump and piping may be hot as well. It may cause of burn. Please do not touch them.
-  - In case of emergency or abnormality, close emergency stop valve.
-  - The screws of the solvent cup may become loose, depending on the environments where the product is being delivered or stored before being used (e.g. the surrounding temperatures or the shakings). Please check the product condition before using it, and retighten the screws according to the section "4.5 Retightening gland packing".
-  - Please do not operate pump when supplying solvent to the solvent cup and retightening gland packing.
-  - In case of following condition, please do not put your face in the material discharge port. There is a risk of splashing liquid with compressed air
 - When removing air from lower pump.
 - Right after replacing material container.
-  - Use this product for the material suitable for the specification. Parts may be corroded and material leak from the damaged parts can lead to environmental pollution. Also, follow handling notes (SDS) of the manufacturer about the handling of the material used.
-  - Take fall-prevention measures if using a slim or light tank. Risk of falling will be increased due to shift in center of gravity caused by change in the material level in a tank.
When using a bung adapter, to prevent the pump from falling over, hang the pump with a crane etc or fix container firmly.
-  - (DR type only) Material remaining inside or on the surface of the pump may spill out by inserting or removing the pump into from a drum. Be very careful not to get your clothing dirty.
-  - Shut off air source after work and nighttime, holidays, or when the pump is not in use for a while. Also, open the valve at the discharge port to release residual pressure in the pump and hoses. Failure to do so may result in damage to the hoses or facility pollution due to leak from the valve. The use has a responsibility for such secondary accidents.

4.1 Operation switch and valve

- Pump Air Regulator (sold separately)
Function : Controlling air pressure for pump operation.
To operate: Clockwise turn will increase pressure. Counterclockwise turn will decrease pressure.
(It can be locked by pushing the knob in.)
Note : The maximum allowable operating pressure of the pump is 0.7 MPa. DO not exceed this limit.
Remark : Discharge pressure can be calculated by multiplying the air pressure by the pump ratio.
- Air Valve, Pump (sold separately)
Function : Starting/Stopping the pump.
To operate: When the lever is parallel to the pipe, the valve is open. If the lever is perpendicular to the pipe, the valve is closed.
In case of emergency, close this valve.

4.2 Solvent cup

(This procedure is not necessary if lower pump has a soak in drum, such as using with drum cover)

- 1) The pump is equipped with a solvent cup to keep the packing from sticking to the plunger. Shut down the pump and then fill the cup 2/3 full with suitable lubricant or solvent.
- 2) When lubricant in the cup runs out during operation, shut down the pump first and refill the cup.

4.3 Filling delivery piping with material

- 1) Open valve for material discharge.
- 2) Open the air valve for the pump and increase air pressure gradually with the pump air regulator. The pump will start operating at approx. 0.05 MPa. Adjust the pump air regulator to set pump speed to 5-8 seconds per cycle.
- 3) Air-containing material will be discharged from the material discharge port. Put a plastic bag over the port to receive discharged material. Keep the pump operating until the air inside material is released completely. Then close the material discharge valve by securely tightening it.
- 4) After filling delivery piping with material, close the air valve for the pump and set the pump air regulator to 0MPa.

4.4 Operation

- 1) Adjust the pump air regulator to set to the desirable operating pressure. An estimate of the material discharge pressure to the supply air pressure is calculated by "supply air pressure × pump ratio".
(e.g. When operating a 13:1 ratio pump at 0.7 MPa supply air pressure, material will be discharged at approx. 9.1MPa.)
- 2) Open discharge valve and the pump will automatically start to operate and discharge the material. When the valve is closed, the pump is automatically stopped.

NOTE

Material viscosity varies with changes in temperature. It is recommended to make a note of appropriate pressure for each season.

4.5 Retightening gland packing ("-V" series)

Because of the deformation or wear of gland packing or temperature change, solvent cup of "-V" series loose the tightness. In order to protect plunger and packing, and to prevent leak, please tighten it on a regular basis. Please do it when the pump is stopped.

NOTE

After retightening, verify that the pump runs at 0.05 MPa without leakage from the gland part.

4.6 When container is empty (changing drum)











- 1) When the container such as drum is empty, the pump continued to operate without stop automatically. Please close the air valve as soon as possible. Then please set air regulator to 0MPa.
- 2) <Used with drum cover>
Lift up the pump and drum cover by crane and replace to new container such as drum.
<Used with bung adapter>
Loosen wing bolt of the bung adapter. Lift up the pump by crane and remove from drum. When new drum is ready, follow "3.3 Installation of Drum Pump (Using a bung adapter: DR-125B13)".
<Siphon pump used with suction tube>
Remove the suction tube from container, and set to new container.
- 3) When changing container, air will contaminate in the pump. Be careful of air-containing material discharged from the material discharge port when restart the pump.
To remove air, please follow chapter 3) of "4.3 Filling delivery piping with material".

4.7 After work





- 1) Close the air valve for the pump and set the pump air regulator to 0 MPa.
- 2) Open the valve on the discharge port to release residual pressure on air and material inside the pump and piping.

5. Maintenance and Inspection

CAUTION

-  - Keep your face away from the exhaust and discharge ports. Material may suddenly come out. There is a possibility of losing eyesight if it strikes eyes.
-  - Keep your fingers away from each port to avoid injury from moving parts.
-  - Modification of this pump may lead to death, bodily injury, or a failure. Do not modify it in any case because it involves a risk.
-  - Gasoline is a high volatile fuel. Do not use it to clean the pump in any case, otherwise ignition or explosion may be caused.
-  - Do not discharge material directly onto the ground. Dispose of harmful materials according to the requirements specified in SDS or local regulations. Also, dispose of pump according to the local regulations after removing residual material from inside pump. (Please contact industrial waste disposal service.)
-  - Always wear proper safety equipments (facemask, ear plugs, and safety shoes, etc.) when installing, operating, and disassembling the pump.
-  - Stop pump operation immediately when a drum becomes empty. Running the pump dry will cause excessive. Be especially careful when pumping explosive material. Mixture of an air and vaporized material can explode. If there is any possibility of running dry, install a dry-run protection device like a liquid level control vibration, resulting in reduction of pump life and damage to other equipment.
-  - Execute the daily checkup.
-  - Before maintenance involving disassembly, be sure to shut off air supply to the pump and release residual air pressure and material pressure in the tubes and pump. Failure to do so may result in material gushing out.
-  - The life of consumables varies depending on operating conditions. Replace a degraded part with a new one.

CAUTION

-  - When performing maintenance or inspection, notify workers by hanging a sign or other method to keep them from touching the unit.
-  - If there is any danger or abnormality, discontinue pump operation and refer to Troubleshooting to solve the problem.
-  - Be sure to shut off air supply to the pump before maintenance and inspection.
-  - When performing maintenance and inspection, please be careful of edge of pump. It may cause of personal injury.

5.1 Maintenance and inspection

INTERVAL	ACTION
Daily	1)Inspect operation of pump.
Weekly	2)Lubricate pump. (turbine oil, class#1, additive-free: ISO V 32)
Annually	3)Check for loose bolts and nuts.
Triennially	4)Overhaul pump.

- 1) Inspect operation of pump
Inspect pump to ensure the following:
 - The pump operates normally and smoothly,
 - There is no air/material leak in each part of the pump or air/material piping,
 - There is no abnormal noise during pump operation, and
 - There is no abrasion or deterioration apparently in each part of the pump.
- 2) Lubricate pump
Lubricate pump according to the following procedure:
 - Close the air valve for the pump and set the pump air regulator knob to 0 MPa.
 (Without a lubricator)
 - Disconnect the air piping from the air inlet of the pump and apply a few drops (approx. 0.5 mL) of lubricant directly to the pump.
 (With a lubricator)
 - Check the amount of oil remaining in the lubricator and fill it with lubricant if needed.
- 3) Check for loose bolts and nuts
Check bolts and nuts according to the following procedures:
 - Completely shut down the pump and lift by disconnecting from the air source, for example.
 - Ensure that all visible bolts and nuts on the pump and lift cannot be loosened by hand.
- 4) Overhaul pump
Pump needs to be overhauled triennially. Please contact the retail store where you purchased your pump or our business office for overhaul. Earlier overhaul is recommended depending on use frequency and deterioration degree.

5.2 Troubleshooting

If you suspect that you have a problem with your product, consult the table below for some common problems and their solutions. Contact the retail store where you purchased your product or our business office if all else fails.

PROBLEM	POSSIBLE CAUSE	REMEDY
Pump doesn't run	Compressor is off.	Turn on compressor.
	Valve on air piping is closed.	Open valve.
	Air pressure setting is under 0.2MPa.	Set air pressure to 0.2 MPa or above.
	Valve on material outlet is closed.	Open valve.
	Frost occurs inside silencer.	Use dry air.
	O ring on sliding part of air piston is worn out. (Air leak occurs from silencer.)	Replace worn out or damaged part.
	Block (773425) and ball (686271) in valve body (804815) are worn out.	
Any parts (e.g. spring, pin) used in switching system in valve body (804815) or air motor (804855 / 804856) are damaged.		
Air leak from air motor	- Fasteners are loose. - O rings and packings are worn out.	- Retighten loose parts. - Replace worn part.
Air leak from silencer during shutdown	- Foreign object is caught between block (773425) and valve seat (716246) in valve body (804815). - Seating part is worn out.	- Remove foreign object. - Replace worn part.
Pump doesn't run and air leaks from silencer	- Foreign object is caught between spindle (716299) and valve switcher (832996) in air motor (804855 / 804856). - There exists damage that prevents sliding movement of parts below.	- Remove foreign object. - Replace damaged part.
Pump doesn't draw material at first time of operation	Pump operating speed is so fast that lower pump suction cannot keep up with pump movement. (Valve inside lower pump is not working well.)	Set pump speed to 5-8 sec. per cycle until material is pumped out.
Material cannot be pumped out	If upward movement of plunger is faster, - seat surface of piston valve is defective (wear of seat surface, inclusion of foreign material) or, - packings are damaged.	- Remove foreign object. - Replace damaged part.
	If downward movement of plunger is faster, - seat surface of foot valve is defective (wear of seat surface, inclusion of foreign material), - packings are damaged, or - shovel rod is bent.	
	If downward movement of plunger is faster, operating speed is so fast that lower pump suction cannot keep up with pump movement. (Vacuum is caused inside lower pump.)	Decrease air pressure until material comes out. (This pressure is the upper limit of normal operating pressure.)
	Connecting rod connecting air motor and lower pump is completely separated from air motor. (In this case, parts inside of lower pump may be damaged.)	Inspect inside lower pump first, then replace damaged part, and retighten each part.
Pump doesn't stop	Leak occurs in delivery pipe.	- Retighten loose parts. - Replace damaged part.
	Leak occurs in lower pump (connections are loosened or o ring, backup ring, or packing is damaged).	
Material leak from lower pump	- Fasteners are loose (loosening of the screws on the solvent cup). - O ring, backup ring or packing is damaged.	- Retighten loosened parts (see Section "4.5 Retightening gland packing" in case of solvent cup). - Replace damaged part.
Material contains air bubbles even after bleeding	- Fasteners are loosened. - O ring or backup ring is damaged.	- Retighten loosened parts. - Replace damaged part.

5.3 Consumables

Refer to chart under for replacement time for consumables used in the pump. The replacement time should be used only as a guide. Consumption varies depending on use conditions. Also, be sure to replace a part when you find any defect like a leak during operation.

■ Air Motor Assembly

Part No.	Description	Q'ty	Times of replacement
<804855> <804856>	Air motor assembly		
640033	O ring	1 per unit	5 million cycles
640072	O ring	1 per unit	5 million cycles
640034	O ring	1 per unit	5 million cycles
570145	Tube	1 per unit	6 years
<804815>	Valve Body Assembly		
716246	Valve seat	1 per unit	10 million cycles
773425	Block	1 per unit	10 million cycles
706612	Spring	1 per unit	10 million cycles
686271	Ball	1 per unit	10 million cycles

■ Lower Pump Assembly

Part No.(Type)				Description	Q'ty	Times of replacement
854592 (SH-125B3.5)	854598 (SH-125B3.5-V)	854594 (SH-125B5)	854600 (SH-125B5-V)			
854593 (DR-125B3.5)	854599 (DR-125B3.5-V)	854595 (DR-125B5)	854601 (DR-125B5-V)			
<804857>	<804861>	<804858>	<804862>	Lower Pump Assembly		
716425		716427		Plunger	1 per unit	10 million cycles
686390		686391		Packing	1 per unit	5 million cycles
	770492		770207	V Packing	3 per unit	3 million cycles
701382		701369		Cylinder	1 per unit	10 million cycles
	630479			Ball	1 per unit	6 million cycles
	701360			Valve Seat	1 per unit	6 million cycles
770493		770208		Packing	2 per unit	3 million cycles
	630487			Ball	1 per unit	6 million cycles
	833004			Foot Valve	1 per unit	6 million cycles

Part No.(Type)		Description	Q'ty	Times of replacement
855262 (SH-125B13)	855263 (DR-125B13)			
<805311>	<805314>	Lower Pump Assembly		
716480		Plunger	1 per unit	10 million cycles
685795		Packing	1 per unit	5 million cycles
704583		Suction Tube	1 per unit	10 million cycles
	704580	Cylinder	1 per unit	10 million cycles
630334		Ball	1 per unit	6 million cycles
710926		Valve Seat	1 per unit	6 million cycles
686404		U Packing	1 per unit	3 million cycles
630341		Ball	1 per unit	6 million cycles
704586	704587	Foot Valve	1 per unit	6 million cycles

5.4 Design standard use period

Design standard use period is established for the product. (See the table below.)

Use of the product beyond this period may result in personal injury or property damage.

- ①SH-125B3.5, DR-125B3.5, SH-125B3.5-V, DR-125B3.5-V 10 years
- ②SH-125B5, DR-125B5, SH-125B5-V, DR-125B5-V 10 years
- ③SH-125B13, DR-125B13 10 years

Standard Conditions of Use	①SH/DR-125B3.5□	②SH/DR-125B5□	③SH/DR-125B13
Application	Pumping grease		
Season	Spring and Fall		
Temperature	20 °C		
Material being pumped	Hydraulic oil ISO VG32 20 °C		Hydraulic oil ISO VG220 20 °C
Container	Open Head Drum (200 L): JIS Z 1601 class 1		
Supply air pressure	0.5 MPa		
Discharge Volume per Cycle	619 mL / cycle	458 mL / cycle	168 mL / cycle
Daily Amount of Material being pumped (Discharge volume)	2000 L	1600 L	600 L
Operating Days per year	260 days (5 days a week)		

6. Parts Disassembly Drawing and Parts List

■ Pump assembly

SH-125B3.5(854592), SH-125B5(854594), SH-125B3.5-V(854598), SH-125B5-V(854600)

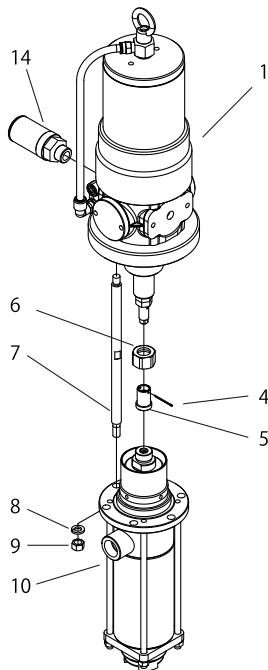

No.	Part No.				Description	Qty
	854592	854594	854598	854600		
1	804855	←	←	←	Air motor assembly	1
4	632059	←	←	←	Slit pin	1
5	716409	←	←	←	Bushing	1
6	700350	←	←	←	Cap nut	1
7	716410	←	←	←	Stud	3
8	631918	←	←	←	Wave spring washer	3
9	627045	←	←	←	Nut	3
10	804857	804858	804861	804862	Lower pump assembly	1
14	804697	←	←	←	Silencer	1

■ Pump assembly

DR-125B3.5(854593), DR-125B5(854595), DR-125B3.5-V(854599), DR-125B5-V(854601)

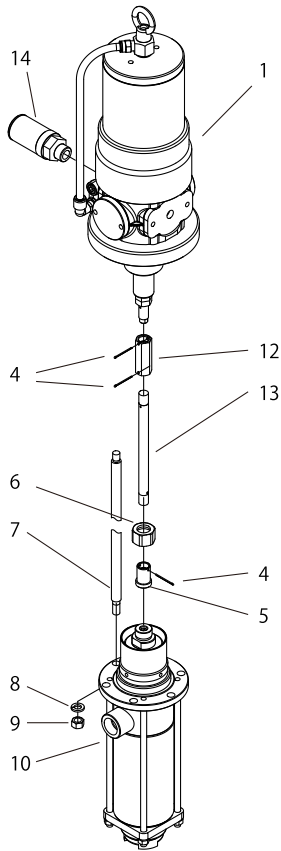

No.	Part No.				Description	Q'ty
	854593	854595	854599	854601		
1	804855	←	←	←	Air motor assembly	1
4	632059	←	←	←	Slit pin	3
5	716409	←	←	←	Bushing	1
6	700350	←	←	←	Cap nut	1
7	716411	←	←	←	Stud	3
8	631918	←	←	←	Wave spring washer	3
9	627045	←	←	←	Nut	3
10	804857	804858	804861	804862	Lower pump assembly	1
12	716288	←	←	←	Joint	1
13	716412	←	←	←	Connecting rod	1
14	804697	←	←	←	Silencer	1

■ Pump assembly

SH-125B13(855262), DR-125B13(855263)

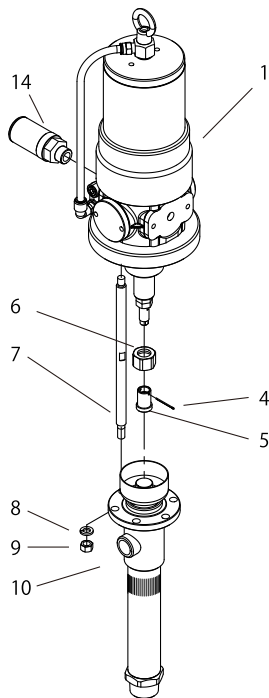

No.	Part No.		Description	Q'ty
	855262	855263		
1	804856	←	Air motor assembly	1
4	632059	←	Slit pin	1
5	716409	←	Bushing	1
6	700350	←	Cap nut	1
7	716410	←	Stud	3
8	631918	←	Wave spring washer	3
9	627045	←	Nut	3
10	805311	805314	Lower pump assembly	1
14	804697	←	Silencer	1

■ Lower pump assembly
804857, 804858(For SH/DR-125B3.5, For SH/DR-125B5)

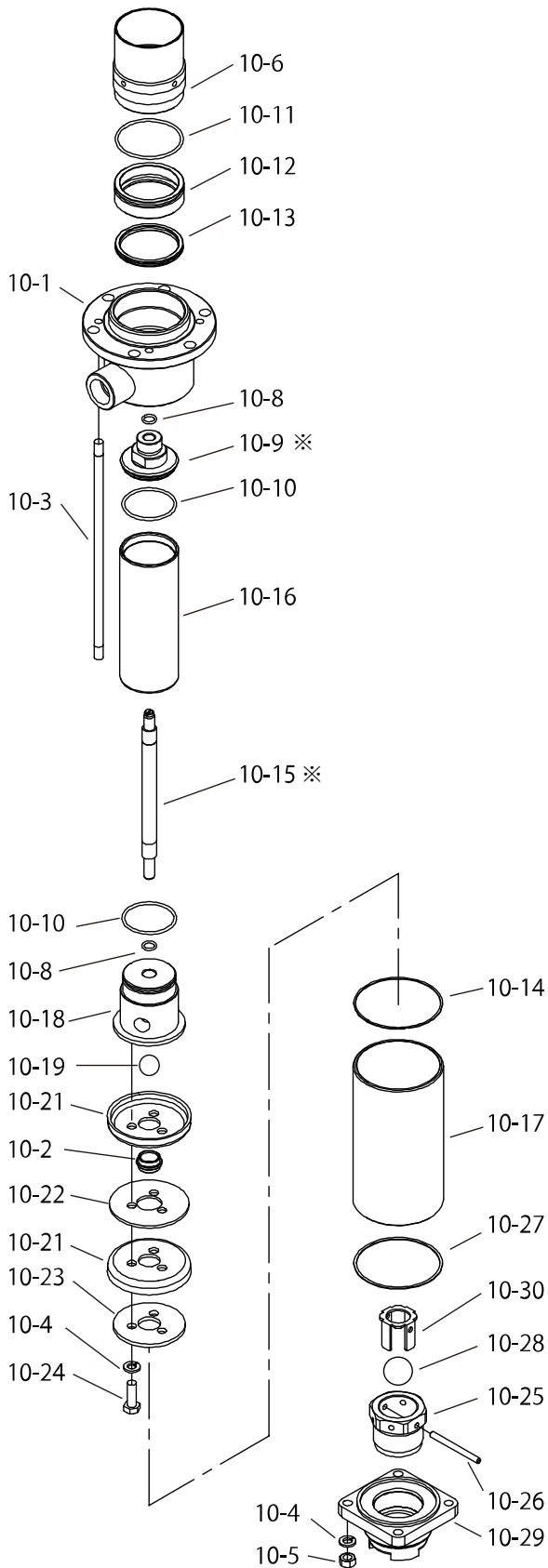

No.	Part No.		Description	Q'ty
	804857	804858		
10-1	833003	←	Body assembly	1
10-2	701360	←	Valve seat	1
10-3	716423	←	Rod	4
10-4	631917	←	Wave spring washer	7
10-5	627013	←	Nut	4
10-6	701355	←	Packing gland	1
10-8	640011	←	O ring	2
10-9	703529	703526	Chamber	1
10-10	640136	640134	O ring	2
10-11	640139	←	O ring	1
10-12	716424	716429	Throat bearing	1
10-13	686390	686391	Packing	1
10-14	701381	701371	Washer	1
10-15	716413	←	Stud	1
10-16	716425	716427	Plunger	1
10-17	701382	701369	Cylinder	1
10-18	704742	704744	Chamber	1
10-19	630479	←	Ball	1
10-21	770493	770208	Packing	2
10-22	701379	701366	Washer	1
10-23	704741	704743	Washer	1
10-24	611175	←	Bolt	3
10-25	833004	←	Foot valve	1
10-26	701359	←	Pin	1
10-27	701388	701362	Washer	1
10-28	630487	←	Ball	1
10-29	701358	←	Foot valve body	1
10-30	716428	←	Ball guide	1

※Connect the upper surface of the chamber (10-9) with the upper end of the stud (10-15).

■ Lower pump assembly
804861, 804862(For SH/DR-125B3.5-V, For SH/DR-125B5-V)

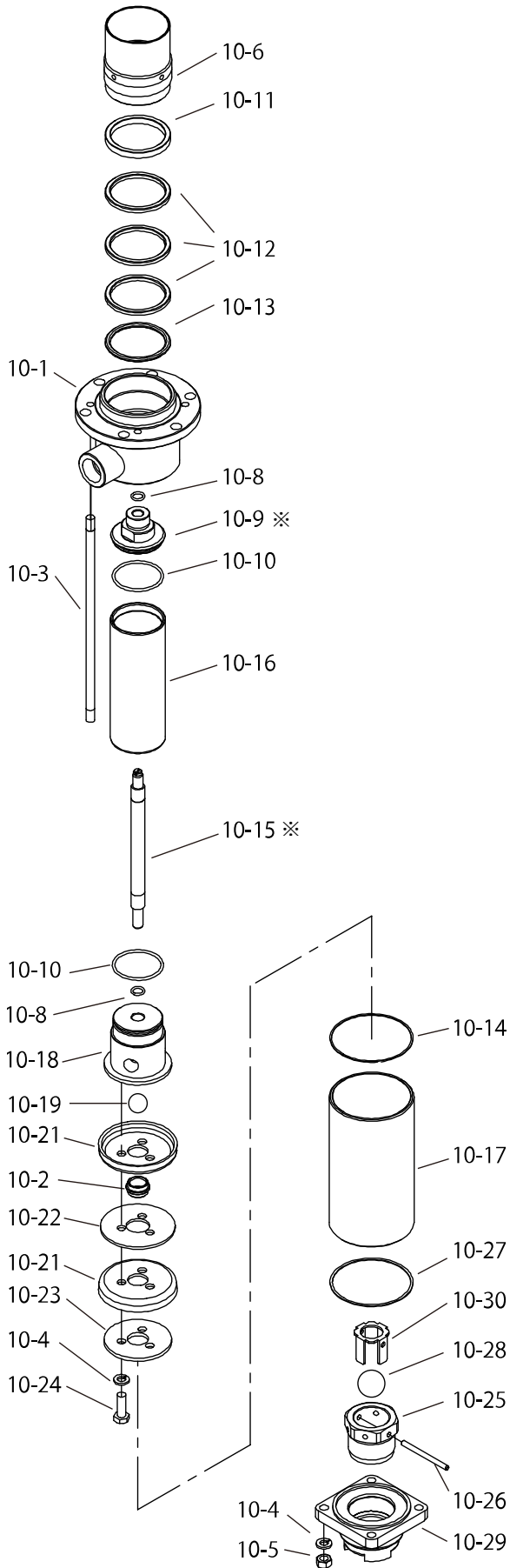

No.	Part No.		Description	Q'ty
	804861	804862		
10-1	833003	←	Body assembly	1
10-2	701360	←	Valve seat	1
10-3	716423	←	Rod	4
10-4	631917	←	Wave spring washer	7
10-5	627013	←	Nut	4
10-6	701355	←	Packing gland	1
10-8	642011	←	O ring	2
10-9	703529	703526	Chamber	1
10-10	642136	642134	O ring	2
10-11	701384	701373	Packing gland	1
10-12	770492	770207	V Packing	3
10-13	701385	701372	Packing gland	1
10-14	701381	701371	Washer	1
10-15	716413	←	Stud	1
10-16	716425	716427	Plunger	1
10-17	701382	701369	Cylinder	1
10-18	704742	704744	chamber	1
10-19	630479	←	Ball	1
10-21	770493	770208	Packing	2
10-22	701379	701366	Washer	1
10-23	704741	704743	Washer	1
10-24	611175	←	Bolt	3
10-25	833004	←	Foot valve	1
10-26	701359	←	Pin	1
10-27	701388	701362	Washer	1
10-28	630487	←	Ball	1
10-29	701358	←	Foot valve body	1
10-30	716428	←	Ball guide	1

※Connect the upper surface of the chamber (10-9) with the upper end of the stud (10-15).

■ Lower pump assembly
805311, 805314 (For SH-125B13, For DR-125B13)

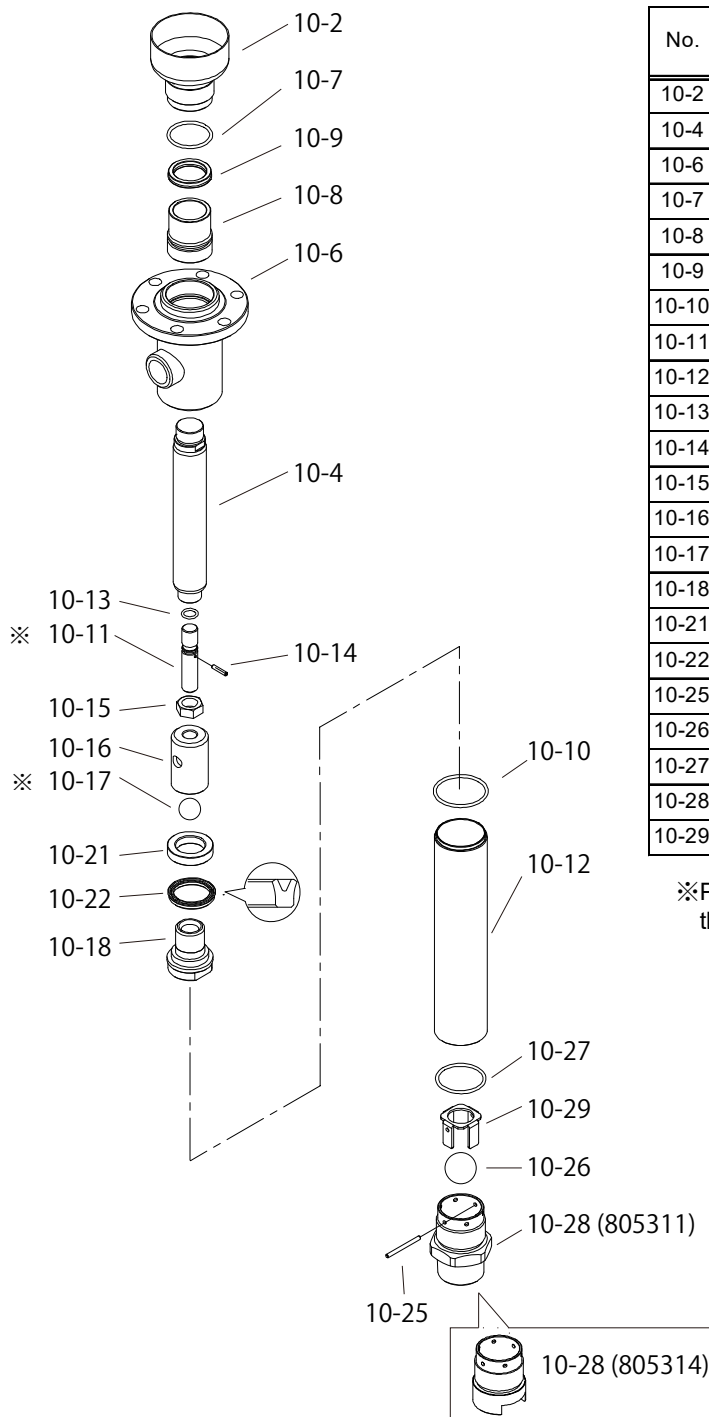

No.	Part No.		Description	Q'ty
	805311	805314		
10-2	833014	←	Solvent cup assembly	1
10-4	716480	←	Plunger	1
10-6	833005	←	Body assembly	1
10-7	640133	←	O ring	1
10-8	716431	←	Throat bearing	1
10-9	685795	←	Packing	1
10-10	640135	←	O ring	1
10-11	701552	716433	Rod	1
10-12	704583	704580	Cylinder(Suction tube)	1
10-13	640012	←	O ring	1
10-14	632774	←	Spring pin	1
10-15	627016	←	Nut	1
10-16	701554	←	Housing	1
10-17	630334	←	Ball	1
10-18	710926	←	Valve seat	1
10-21	710925	←	Collar	1
10-22	686404	←	U packing	1
10-25	701556	←	Pin	1
10-26	630341	←	Ball	1
10-27	640134	←	O ring	1
10-28	704586	704587	Foot valve	1
10-29	716432	←	Ball guide	1

※Please adjust the gap between the lower end of the rod (10-11) and the ball (10-17) to $3\pm 0.5\text{mm}$.

7. Specifications

■ Specifications

Type	SH-125B3.5	DR-125B3.5	SH-125B5	DR-125B5	SH-125B13	DR-125B13
Model No.	854592	854593	854594	854595	855262	855263
Pump Ratio (Nominal)	3.5 × 1		5 × 1		13 × 1	
Material Connection	Suction port	Rc 1-1/2			R 1-1/2	————
	Discharge Port	Rc 1			Rc 3/4	
Air Connection	Supply Port	Rc 3/8				
Operating Air Pressure		0.2 ~ 0.7 MPa				
Maximum operating noise	A-weighted Sound Pressure Level* ¹	83.8 dB			78.4 dB	
	A-weighted Sound Power Level* ²	92.2 dB			88.4 dB	
Amb. Temp. Range	Temp. Ambient	0 ~ 60 °C				
	Temp. Material	0 ~ 80 °C				
Stroke(Nominal)		100 mm				
Discharge Volume per Cycle * ³		619 mL	458 mL	168 mL		
Maximum Discharge Pressure		2.45 MPa	3.5 MPa	9.1 MPa		
Weight		28.9 kg	30.5 kg	27.3 kg	28.9 kg	22.7 kg 26.1 kg

Type	SH-125B3.5-V	DR-125B3.5-V	SH-125B5-V	DR-125B5-V
Model No.	854598	854599	854600	854601
Pump Ratio (Nominal)	3.5 × 1		5 × 1	
Material Connection	Suction port	Rc 1-1/2		
	Discharge Port	Rc 1		
Air Connection	Supply Port	Rc 3/8		
Operating Air Pressure		0.2 ~ 0.7 MPa		
Maximum operating noise	A-weighted Sound Pressure Level* ¹	83.8 dB		
	A-weighted Sound Power Level* ²	92.2 dB		
Amb. Temp. Range	Temp. Ambient	0 ~ 60 °C		
	Temp. Material	0 ~ 80 °C		
Stroke(Nominal)		100 mm		
Discharge Volume per Cycle * ³		619 mL	458 mL	
Maximum Discharge Pressure		2.45 MPa	3.5 MPa	
Weight		28.9 kg	30.5 kg	27.2 kg 28.8 kg

*1 Measurement method of A-weighted sound pressure level is based on ISO 1996.

*2 Measurement method of A-weighted sound power level is based on ISO 3744.

*3 Discharge volume (per cycle) varies according to use conditions.

■ Dimensions

①SH-125B3.5/5□ ②DR-125B3.5/5□ ③SH-125B13 ④DR-125B13

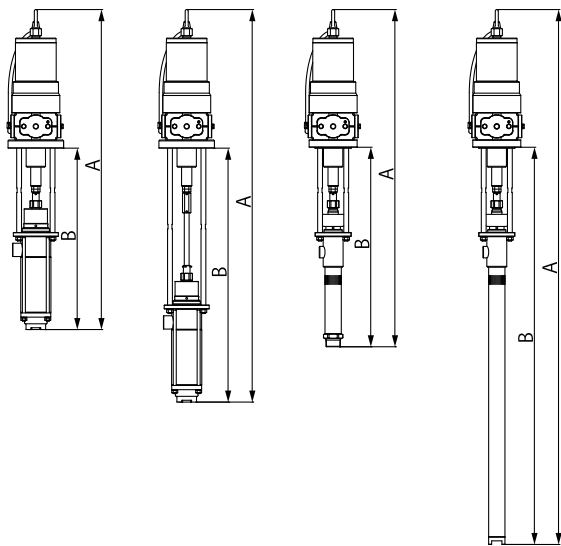

	Part No.	A mm	B mm
①	854592	1058	600
	854594		
	854598		
	854600		
②	854593	1298	840
	854595		
	854599		
	854601		
③	855262	1115	660
④	855263	1769	1314

■ Performance curve

<NOTE>

Avoid continuous operation if a desired discharge volume is in the shaded area in the right side of each figure.

SH/DR-125B3.5, SH/DR-125B3.5-V

TEST MATERIAL : INDUSTRIAL LUBRICANT (ISO VG32)
FLUID TEMPERATURE : 28.0 °C

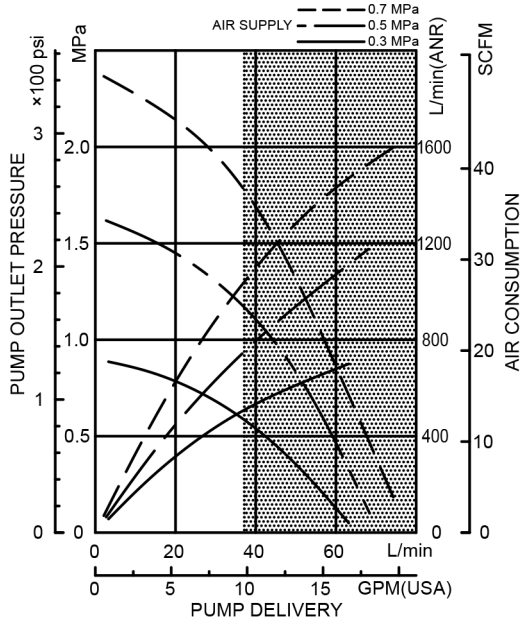

SH/DR-125B5, SH/DR-125B5-V

TEST MATERIAL : INDUSTRIAL LUBRICANT (ISO VG32)
FLUID TEMPERATURE : 26.0 °C

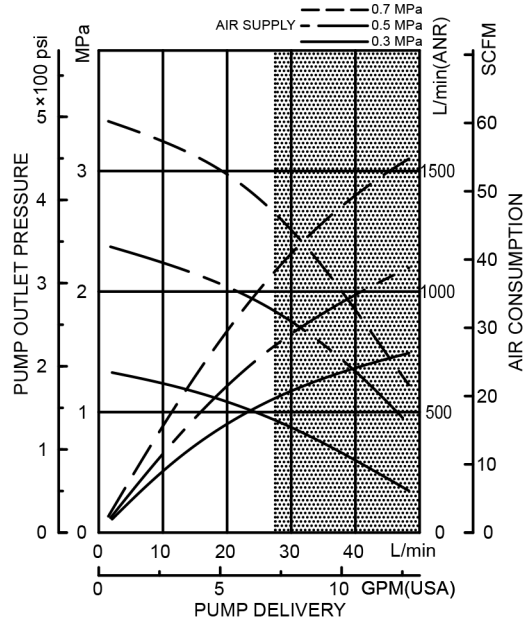

TEST MATERIAL : INDUSTRIAL LUBRICANT (ISO VG220)
FLUID TEMPERATURE : 25.8 °C

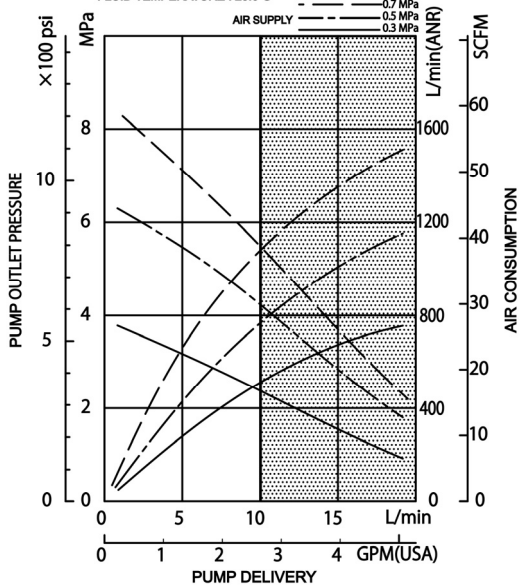

SH/DR-125B13

8. Limited Warranty

If an abnormality occurs during normal operation in accordance with the operating instructions and other operating cautions within the warranty period (12 months after date of purchase) that can be attributed to a manufacturing defect, the defective parts of this product will be serviced or the product will be replaced free of charge. However, this warranty will not cover compensation for incidental damage or any malfunction listed below.

1. Warranty period

This warranty will be valid for a period of 12 months after the date of purchase.

2. Warranty

If, during the warranty period, any of the material of the genuine parts of this product or the workmanship of this product is found defective, and is so verified by our company, the servicing cost will be fully born by our company.

3. Exclusion

Even during the warranty period, this warranty does not cover the following.

- 1) Malfunction arising from use of parts other than manufacturer-specified genuine parts
- 2) Malfunction arising from misuse or operating errors, or lack of storage or maintenance care
- 3) Malfunction arising from use with a fluid that may cause corrosion, inflation or dissolution of the component parts of the product
- 4) Irregularity arising from repair made by other than by our firm, our regional office, dealer or authorized service personnel
- 5) Malfunction arising from modification of the product by other than authorized service personnel
- 6) Wear and tear of parts that must be regularly replaced in the course of normal operation, such as packings, O-rings and hose.
- 7) Malfunction and/or damage due to use with incorrect voltage.
- 8) Malfunction and/or damage due to transportation, moving or drop page of the product after purchase
- 9) Malfunction and/or damage due to fire, earthquake, flood or other force majeure
- 10) Malfunction arising from use of compressed air that contains impurities or excessive moisture, or use of gases or fluids other than the specified compressed air
- 11) Malfunction arising from use of excessively abrasive material or of inadequate grease.

Furthermore, this warranty does not cover the rubber parts, or other parts used in this product and its accessories, which are subject to wear in normal operation.

- hoses
- packings
- cords

4. Parts

Parts for this product will be kept available for 5 years after discontinuation of production. Once 5 years have elapsed after close of production, availability of parts for this product cannot be guaranteed.

YAMADA CORPORATION

INTERNATIONAL DEPARTMENT

1-1-3, Minami-Magome, Ota ku, Tokyo, 143-8504, Japan

PHONE : +81-(0)3-3777-0241

FAX : +81-(0)3-3777-0584

E-mail : intl@yamadacorp.co.jp

Web : www.yamadacorp.co.jp

YAMADA (THAILAND) CO., LTD

41/79 Moo 6, Bangcha-long, Bangplee, Sumutprakarn 10540, Thailand

PHONE : +66-(0)2-130-0990

FAX : +66-(0)2-130-0993

E-mail : sales@yamada-th.com